



CROSSROAD[®]
DISTRIBUTOR SOURCE



**POWERCOIL
LOKSERT
BONDSERT**

**THREADED INSERTS
& THREAD RESTORATION
BUYER'S GUIDE 07/2021**



	Free Running Insert Filet rapporté standard Inserto standard		8-UN Constant Pitch Pas constant 8-UN Rosca Americana paso 8 hilos		MC, MF, UNC, UNF, 8 Pitch, NPT – HSS Bottoming STI Tap Taraud STI finisseur MC, MF, UNC, UNF, 8 pas, NPT – HSS Macho STI de acabado, N° 3 – MC, MF, UNC, UNF, 8 UN, NPT
	Screw Locking Insert Filet rapporté à frein de vis Inserto autofrenante		British Association Association britannique Rosca inglesa BA		MC, MF, UNC, UNF, 8 Pitch, NPT – HSS Intermediate STI Tap Taraud STI intermédiaire MC, MF, UNC, UNF, 8 pas, NPT – HSS Macho STI intermedio, N° 2 – MC, MF, UNC, UNF, 8 UN, NPT
	Metric Coarse Métrique à pas normaux Métrica gruesa		British Standard Brass Standard Anglais BSCY Rosca inglesa BSC		MC, MF, UNC, UNF, 8 Pitch, NPT – HSS Taper STI Tap Taraud STI ébaucheur MC, MF, UNC, UNF, 8 pas, NPT – HSS Macho STI conico, N° 1 – MC, MF, UNC, UNF, 8 UN, NPT
	Metric Fine Métrique à pas fins Métrica fina		Installed Insert Length = Diameter x 1.0 Longueur du filet rapporté installé = Diamètre x 1.0 Longitud del inserto instalado = Diámetro x 1		Spark Plug – HSS Pilot Nose STI Tap Taraud STI à embout pilote bougie d'allumage - HSS Macho STI con double entrée para bujias
	Unified National Coarse Pas normal américain Rosca Americana gruesa		Installed Insert Length = Diameter x 1.5 Longueur du filet rapporté installé = Diamètre x 1.5 Longitud del inserto instalado = Diámetro x 1,5		
	Unified National Fine Pas fin américain Rosca Americana fina		Installed Insert Length = Diameter x 2.0 Longueur du filet rapporté installé = Diamètre x 2.0 Longitud del inserto instalado = Diámetro x 2		
	British Standard Whitworth Pas normal britannique Rosca inglesa gruesa		Installed Insert Length = Diameter x 2.5 Longueur du filet rapporté installé = Diamètre x 2.5 Longitud del inserto instalado = Diámetro x 2,5		
	British Standard Fine Pas fin britannique Rosca inglesa fina		Installed Insert Length = Diameter x 3.0 Longueur du filet rapporté installé = Diamètre x 3.0 Longitud del inserto instalado = Diámetro x 3		
	British Standard Pipe Filet de tube britannique Rosca inglesa GAS		HSS-EV Spiral Flute STI Tap Taraud STI à rainures hélicoïdales HSS-EV Macho STI Hélicoïdal		
	National Pipe Taper tube conique américain Rosca cónica Americana		HSS-EV Spiral Point (Gun Nose) STI Tap Taraud STI à entrée hélicoïdale (nez mitrailleuse) HSS-EV Macho STI con entrada corregida F/B		

PowerCoil Wire Thread Inserts strengthen tapped threads in light weight parent materials such as aluminum. They are helically wound inserts made from high quality chromium nickel stainless steel with a diamond shaped cross section.

PowerCoil inserts are used in OEM applications in a wide range of industry sectors including aerospace, automotive, military and electronics. They are inexpensive when compared to other inserts and simple to install, yet are extremely tough, wear resistant and corrosion resistant.

Most importantly, PowerCoil inserts allow the stress loading from the bolt or similar threaded part to be more evenly distributed over the threads in the parent material.

In addition to PowerCoil standard 'free running' inserts, 'screw locking' inserts are also available. These inserts have polygonal grip coils within the length of the insert which exert radial pressure on the male thread, thereby gripping the bolt and preventing it from loosening under vibration or impact.

In addition to stainless steel, PowerCoil inserts can be made

from Phosphor Bronze, Inconel or Nimonic 90 depending on the application. They can also be supplied with different surface finishes and coatings including cadmium, silver and zinc plating and dry film lubricant.

The PowerCoil Wire Thread Insert System® consists of high quality wire thread inserts, quality high-speed taps, drills and easy-to-use installation tools for the repair of damaged internal threads or creation of strong new internal threads in original equipment. Bulk insert stock available to MS/NASM and MA standards.



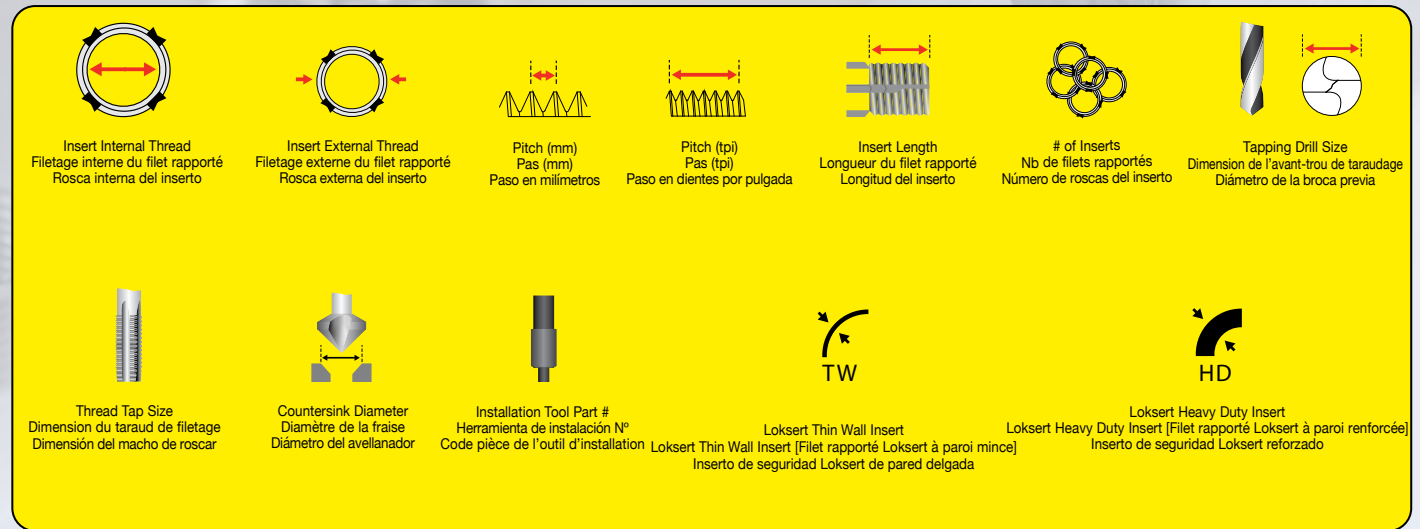

Loksert solid keylocking inserts are an easily installed thread assembly that is ideal for replacing damaged or worn threads in virtually any material – ferrous, non-ferrous and non-metallic.

They are constructed from high quality carbon steel or extremely hard wearing stainless steel. One piece loksert inserts are supplied with the dove-tailed locking keys pre-assembled. Lokserts are suitable for repairing and creating threads in a wide range of applications including forgings and castings and are especially suited to situations that experience heavy wear and vibration - such as mining, construction and earthmoving equipment.

Features and Benefits

- Solid bushing utilizing locking keys provides positive mechanical lock against rotation
- High strength and reliability provides maximum pullout strength
- Installed using standard drills and taps
- Simple installation - no special skills required
- Suitable for use in a wide range of parent materials
- Impossible to cross thread during installation
- Simple removal process if required
- No tang to break and remove
- Available in metric sizes, inch sizes and spark plug sizes
- Available in Thinwall and Heavy Duty



Los insertos de seguridad Loksert son de fácil instalación, y su ensamblaje es ideal para reemplazar roscas dañadas o gastadas en, esencialmente, cualquier material – ferroso, no ferroso y no metálico -. Están fabricados con la más alta calidad de acero al carbón o de acero inoxidable. Un inserto loksert se suministra con los arrastres pre-ensamblados. Los filetes de apriete posicionados automáticamente colocan al inserto en la profundidad correcta de la superficie del material de alojamiento. Los lokserts están recomendados para reparación y creación de roscas en un amplio rango de aplicaciones incluyendo herrerías y fundiciones y se recomiendan especialmente para casos de gran desgaste de uso y vibración, tales como minería, construcción y equipo de gran movimiento.

Características y Beneficios

- Sólidos, utilizan filetes de apriete que proporcionan una alta seguridad mecánica contra la rotación.
- Alta resistencia y fiabilidad que proporciona una gran resistencia contra el desplazamiento.
- Se instalan usando machos y brocas standard.
- Instalación sencilla. No requiere de conocimientos especiales
- Recomendados para su uso en un amplio rango de materiales de alojamiento.
- Imposible de confundir las roscas durante la instalación.
- En caso de ser necesario, sencillo proceso de desalajo.
- Sin arrastre que cortar y quitar
- Disponibles en medidas métricas, pulgadas y para bujías
- Disponible en paredes delgadas y para trabajos pesados



Les Loksert solid keylocking inserts [solides filets rapportés Loksert à frein de vis] sont un assemblage de filet facile à implanter et idéal pour remplacer les filets endommagés ou usés pour n'importe quel type de matériau, ferreux, non ferreux et non métallique. Ils sont fabriqués à partir d'acier au carbone de haute qualité ou d'acier inoxydable extrêmement résistant à l'usure. Les Loksert inserts [filets rapportés Loksert] en une seule pièce sont fournis avec les clavettes de blocage à queue d'aronde préassemblées. Les clavettes pré-positionnées mettent automatiquement le filet rapporté en place à la profondeur correcte en-dessous de la surface du matériau récepteur. Les Lokserts [filets rapportés Loksert] conviennent à la réparation et à la création de filets pour une large gamme d'applications, y compris pour les forgeages et les moulages, et ils conviennent particulièrement aux situations qui subissent une forte usure et de fortes vibrations, tels que les équipements miniers, le matériel de construction et de terrassement.

Caractéristiques et avantages

- Une douille solide utilisant des clavettes de blocage fournit une résistance mécanique contre la rotation
- La grande résistance et la fiabilité procurent une résistance maximale à l'arrachement
- L'installation se fait à l'aide de forets et de tarauds standards
- L'installation est simple, aucune compétence spéciale n'est requise
- Ils sont appropriés à l'utilisation dans une gamme variée de matériaux récepteurs
- Impossible à fausser durant l'installation
- Facile à retirer si nécessaire
- Aucun tenon à casser et à retirer
- Disponibles en dimensions métriques, en pouces et en dimensions de bougie d'allumage
- Disponibles avec paroi fine et renforcée



Part No. 3520 - 12.00 X 1.5D

- 35 PowerCoil - Stainless Steel
- 36 Loksert - Carbon Steel
- 37 Loksert - Stainless Steel

DIAMETER
XX . XX Metric
XX / XX Imperial

- 20 Metric Coarse 32 UNC
- 21 Metric Fine 34 UNF
- 22 Spark Plug 44 BA
- 23 Metric Fine 46 BSP
- 24 Metric Fine 52 NPT
- 28 BSW 60 BSC
- 30 BSF 70 8-UN
- 00 Multifunctional

- X.X.D Insert length as a factor of nominal screw
- IR PowerCoil strip-feed reel
- SL PowerCoil screw locking
- K PowerCoil thread repair kit
- P PowerCoil Hang sell insert packet
- WK PowerCoil workshop kit
- HIT Hand installation tool
- HIP Prewinder installation tool
- MIT Machine installation tool
- HIM Hex drive installation mandrel
- MIP Pneumatic installation tool
- TB Tang break tool
- STB Spring loaded tang break tool
- PTB Pneumatic tang break tool
- RT Removal/extraction tool
- LH Left Hand
- GC Gauge STI 4H5H tolerance
- GM Gauge STI 6H tolerance

- PB Phosphor bronze
- IC Inconel X-750
- NT Nitronic 60
- Y 316 Stainless Steel
- CD Cadmium plate
- AG Silver plate
- W Dry film lubricant
- XY Xylam Formula 5230/1131 Gray Black
- I Tap Intermediate STI
- T Tap Taper STI
- B Tap Bottoming STI
- SF Tap Spiral Flute STI
- SP Tap Spiral Point STI
- FT Tap Fluteless STI
- TW Loksert Thin Wall
- HD Loksert Heavy Duty
- TT Loksert Thin Wall install tool
- HT Loksert Heavy Duty install tool
- T Loksert Universal install tool



No. De Parte 3520-12.00 X 1,5D

- 35 PowerCoil en acero inoxidable
- 36 Loksert en acero al carbón
- 37 Loksert en acero inoxidable

DIAMETER
XX . XX Métrico
XX / XX Pulgadas

- 20 Métrico grueso 32 UNC
- 21 Métrico fino 34 UNF
- 22 Bujía 44 BA
- 23 Métrico fino 46 BSP
- 24 Métrico fino 52 NPT
- 28 BSW 60 BSC
- 30 BSF 70 8-UN
- 00 Multifuncional

- X.X.D Longitud del inserto teniendo en cuenta la longitud del tornillo
- IR Power Coil, Carrete de alimentación de insertos
- SL Power Coil, insertos autoblocantes (de seguridad) (autofrenantes)
- K Power Coil, Juego de reparación de roscas
- P Power Coil, paquetes de insertos para colgar
- WK Power Coil, Juegos para taller
- HIT Herramienta de instalación manual
- HIP Herramienta de instalación de roscas
- MIT Herramienta para insertar a máquina
- HIM Herramienta para insertar con mango hexagonal
- MIP Herramienta de instalación neumática
- TB Herramienta rompe arrastre
- STB Herramienta rompe arrastre automático
- PTB Herramienta rompe arrastre neumática
- RT Herramienta extractora de insertos
- LH Giro izquierda
- GC Roscas en tolerancia STI 4H5H
- GM Roscas en tolerancia STI 6H

- PB Bronce con fósforo
- IC Iconel X-750
- NT Nitronic 60
- Y Acero inoxidable 316
- CD Terminado en cadmio
- AG Terminado de plata lubricado en seco
- XY Terminado de Xylam Formula 5230/1131 negro gris
- I Macho 2º o intermedio STI
- T Macho 1º o cónico STI
- B Macho 3º o de acabado STI
- SF Macho helicoidal STI
- SP Macho con entrada corregida STI
- FT Macho laminación STI
- TW Loksert de pared delgada
- HD Loksert para trabajos pesados (duros)
- TT Herramienta instalación de Loksert de pared delgada
- HT Herramienta instalación de Loksert para trabajos pesados
- T Herramienta de instalación universal para Loksert



Pièce Nr. 3520 - 12.00 X 1.5D

- 35 PowerCoil - Acier inoxydable
- 36 Loksert - Acier au carbone
- 37 Loksert - Acier inoxydable

DIAMETER
XX . XX Métrique
XX / XX Impérial

- 20 Métrique à pas normal 32 UNC
- 21 Métrique à pas fins 34 UNF
- 22 Bougie d'allumage 44 BA
- 23 Métrique à pas fins 46 BSP
- 24 Métrique à pas fins 52 NPT
- 28 BSW 60 BSC
- 30 BSF 70 8-UN
- 00 Multifonctionnel

- X.X.D Longueur du filet rapporté tel que facteur de serrage nominal
- IR Moulinet d'entraînement de bande PowerCoil
- SL PowerCoil à frein de vis
- K kit de réparation de filets PowerCoil
- P Paquet de filets rapportés PowerCoil dans un emballage à système d'accroche
- WK PowerCoil kit d'atelier
- HIT Outil d'installation manuel
- HIP outil d'installation de pré-enroulage
- MIT Outil d'installation de la machine
- HIM mandrin d'installation Hex
- MIP Outil pneumatique d'installation
- TB Tenon
- STB Tenon à ressort
- PTB Pneumatic tang break tool
- RT Outil de dépose / d'extraction
- LH Coupe à gauche
- GC Jauge STI de tolérance 4H5H
- GM Jauge STI de tolérance 6H

- PB Bronze de phosphore
- IC Inconel X-750
- NT Nitronic 60
- Y Acier inoxydable 316
- CD Plaque de cadmium
- AG Plaque d'argent
- FL film de lubrifiant hydrofuge
- XY Plaque de Xylam Formula 5230/1131 gris, noir
- I Taraud STI intermédiaire
- T Taraud STI ébaucheur
- B Taraud STI finisseur
- SF Taraud STI à rainures hélicoïdales
- SP Taraud STI à entrée hélicoïdale
- FT Taraud STI sans goujure
- TW Loksert à paroi fine
- HD Loksert à paroi renforcée
- TT Outil d'installation de Loksert à paroi fine
- HT Outil d'installation de Loksert à paroi renforcée
- T Outil d'installation universel de Loksert

STANDARD TERMS & CONDITIONS – POWERCOIL[®], LOKSERT[®], BONDSERT

PAYMENT TERMS: Net 30 days, no further credit after 45 days

FREIGHT: F.O.B. Noblesville, IN

Freight Prepaid Policy:

- PowerCoil: \$400 net
- Loksert: FOB Noblesville, IN
- BONDSERT: FOB Noblesville,

MINIMUM ORDER: \$25 Net for open account, No minimum for next day air, or credit card orders

PRICING: Prices are based on purchases of standard package quantities shown.

RETURNED GOODS/CREDIT POLICY:

1. Authorization for return of goods must be approved by our Customer Service representative. If there has been a shipping error, please contact us and we will issue a Return Goods Authorization immediately. **CARTONS THAT DO NOT CARRY AN RGA NUMBER WILL NOT BE ACCEPTED.**
2. Annual inventory adjustments will be negotiated individually, and would apply only to standard stock items that do not require any repackaging.
3. Items that must be repackaged are not eligible for return/credit.
4. Credit for returned goods will be processed on the basis of the prices paid, and must be substantiated by invoice copy.
5. Freight charges for returned goods (other than shipper mistakes) are to be paid by the distributor.
6. Credit for all returns is subject to inspection and acceptance.

PRICES & TERMS SUBJECT TO CHANGE WITHOUT NOTICE

NOTICE: The material presented here is for guidance only. The user assumes full responsibility for determining the suitability of our products for a particular application. Requests for more information are welcome.

DISCLAIMER: SELLER MAKES NO WARRANTY WHATSOEVER, EXPRESSED OR IMPLIED AND ALL IMPLIED WARRANTIES OF MERCHANTABILITY FOR A PARTICULAR PURPOSE ARE DISCLAIMED AND EXCLUDED FROM ALL TRANSACTIONS AND SHALL NOT APPLY TO GOODS SOLD.

REMEDY: Our obligation is limited to the repair or replacement for defective parts or, at our option, the refund of the purchase price. **IN NO EVENT SHALL THE SELLER BE LIABLE FOR ANY INCIDENTAL, SPECIAL OR CONSEQUENTIAL DAMAGES, OR ANY DAMAGES IN THE NATURE OF PENALTIES.**



powercoil[®]
wire thread insert system

Introduction to Wire Thread Inserts	2
Repair Kits.....	6
Workshop (Range) Kits	11
Insert Hang Sell (Retail) Packets.....	13
Merchandisers	20
Bulk Inserts	22
Strip Feed.....	28
STI Taps	29
Installation and Removal Tools	33
Technical Data	40



loksert[®]

Repair Kits.....	46
Insert Hang Sell (Retail) Packets.....	48
Merchandise	49
Bulk Thinwall Inserts	50
Bulk Heavy Duty Inserts	51
Installation Tools	55
Technical Data	56



bondsert[®]

Carbon Steel Inserts	58
Carbon Steel Inserts - Automotive	60
Stainless Steel Inserts	61
Kits	62
Technical Data.....	64

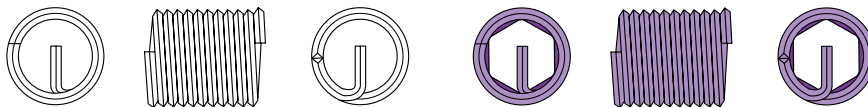

Manufactured from high quality chromium nickel stainless steel, PowerCoil Wire Thread Inserts provide high strength internal threads that resist the effects of temperature and corrosion. Their unique design ensures superior threads whose compound performance cannot be reproduced by any other single fastening method. Available in two basic forms, free running or screw locking, they are much lighter and less expensive than any other equivalent type of thread insert and because of their compact size they can generally be incorporated into existing designs where no previous provision has been made.

FREE RUNNING

Produced from precision profiled austenitic stainless steel wire wound into a helical spiral, PowerCoil free running inserts have a spring like appearance. When installed, using any one of a variety of manual or automatic tools, they provide strong permanent internal threads which resist heat and corrosion. Once fitted, their position is maintained by the action of radial pressure between their coils and the flanks of the tapped hole. This pressure exists because their free diameter is larger by a calculated amount, than their installed diameter.

SCREW LOCKING

Screw locking (or prevailing torque) inserts are of particular value in applications subject to the effects of cyclic vibration or impact. In addition to the benefits afforded by free running inserts, PowerCoil screw locking inserts offer the additional security of prevailing locking torque. This is achieved by the action of one or more polygonal grip coils positioned within the insert's length, which exert radial pressure on the male thread. Each grip coil consists of a number of tangential locking chords which protrude inside the minor diameter of the normal free running coils. As the male thread passes through these grip coils, the locking flats are displaced thus exerting radial pressure or prevailing torque on the male thread. On removal of the male thread, the locking coils relax to their original form permitting repeated assembly while retaining a measurable level of prevailing torque.

Note: It is recommended that only close fit plated or lubricated bolts or screws are used with screw locking inserts.

FEATURES & BENEFITS

For many years, helically coiled wire thread inserts have been vastly underestimated. The popular misconception that they were designed for the repair of damaged threads has given this unique fastener a false image.

They are much lighter and less expensive than any other equivalent type of thread insert and because of their compact size, can generally be introduced into existing designs where no previous provision has been made. Unlike many other economic measures, their introduction increases quality and performance while reducing overall product cost. Their introduction may result in the use of thinner sections or lighter parent materials without sacrificing thread strength.

They protect tapped threads against failures due to stripping, seizing, corrosion and wear. PowerCoil wire thread inserts are produced from austenitic stainless steel wire which is work hardened to a tensile strength above 200,000psi and a hardness of Rc43-50. The inserts have an exceedingly smooth surface finish which virtually eliminates friction-induced thread erosion.

The continuous helically coiled design negates the need for thick wall structures to support the internal and external threads - the diamond profile wire coil is the thread. PowerCoil wire thread inserts can be installed in reduced size bosses or flanges and within constricted areas - saving space and weight while providing high strength.

A boss radius equal to the nominal bolt diameter is usually sufficient.

A complete range of installation tools are available to suit specific production techniques. A range of hand tools exist for small runs and repairs; electric and pneumatic tools are available for high volume production requirements.

STRENGTH

Due to their flexibility, wire thread inserts create internal threads which have a much improved distribution of residual stress loading when compared with conventional tapped holes, where 75% of the shearing forces are carried by the first three threads in the tapped hole. The flexibility of wire thread inserts helps to compensate for pitch and flank angle errors, inherent in normal tapped holes, and significantly enhances the load bearing capacity by deflecting the residual forces into a helical hoop stress which is dispersed into the wall of the tapped hole. This enables the design to be confidently based on the bolt strength utilizing smaller and shorter threads even when used in low strength materials.

The high tensile coils of a wire thread insert undergo a diameter reduction during installation. The outward spring-like force of the coils "locks" the insert into place.

Each coil can flex independently to contact the greatest amount of parent material thread surface. Both static and dynamic load bearing capabilities are improved.

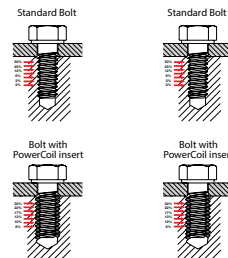

ELIMINATE STRESS

Virtually no stress is introduced into the parent material because there is no staking, locking, swaging or keying in place. The outward "spring action" of the insert holds it in place.

WEAR RESISTANCE

The combination of material hardness and the brilliant surface finish of wire thread inserts creates internal threads in which wear due to thread friction is virtually eliminated. This is of particular value in applications requiring repeated assembly & disassembly. The low frictional coefficient ensures that virtually all of the applied assembly torque is converted into clamping load. Thus providing threads that stay tight.

CORROSION PROTECTION

The 18/8 austenitic stainless steel wire used in PowerCoil inserts resists corrosion under normal environmental conditions. Galvanic action within the thread assembly is reduced, increasing the life of the fastening assembly.

Galvanic corrosion is most significant form of corrosion affecting inserts and fasteners. Galvanic corrosion occurs when dissimilar metals are in contact in the presence of an electrolytic solution. All metals exhibit different degrees of "activity" or "nobility" and can be arranged in a galvanic series of increasing activity. Gold and platinum are most noble while zinc and magnesium are most active. The most common electrolytic solution encountered is ordinary water. Seawater or salt spray is more damaging because of high concentrations of dissolved salts.

The best way to preclude galvanic corrosion is to use similar potential metals and eliminate the electrolyte conductor. The active

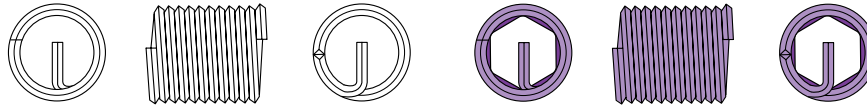

stainless steel of PowerCoil wire thread inserts are not passivated. This minimizes the possibility of galvanic corrosion occurring when they are installed in aluminum or magnesium parent materials.

Some additional precautions for reducing galvanic corrosion are:

1. Isolate the fasteners from the electrolyte. This can be done through gasketing or sealing.
2. Specify cadmium plated inserts. The cadmium plate provides a sacrificial barrier against corrosion. In addition, the cadmium plate has lubricating properties that minimize galling when stainless steel screws are used.
3. Apply corrosion inhibiting pastes or compounds to the screw. These include zinc chromate primer (MIL-P-8585) and strontium chromate primer (MIL-P-23377). Note: Pastes applied to the PowerCoil Thread Insert can become trapped between the wire and the hole and cause loss of proper tolerance. It is therefore recommended to apply the paste only to the screw, not the insert. If zinc chromate primer is applied to the tapped hole it should be thinned and applied sparingly. The insert should be installed while the primer is still wet.
4. Specify a dry film lubricant such as molybdenum disulphide on the inserts. This provides a secondary barrier against corrosion.
5. Where practical or where it will not interfere with the completed assembly, the external joint should be coated with a suitable paint.

MATERIALS

PowerCoil standard inserts are manufactured from fully certified, aircraft quality, 304 (18/8) austenitic stainless steel in accordance with AS7245. Alternative materials include 316 stainless steel and a variety of application specific surface coatings.

ALTERNATIVE MATERIALS

Phosphor Bronze

Non ferrous copper/tin alloy in accordance with BS2783 PB 102 EH – is suitable for operation in temperatures ranging from -200°C to +300°C.

Inconel X-750

Heat resisting precipitation hardenable nickel base alloy (equivalent specifications SAE AS 7246, DIN/NF 3018, W.NR 2.4669, UNS N07750). Inconel X-750 is suitable for operation in temperatures ranging from -200°C to +550° degrees celsius.

Nimonic 90

Heat resisting precipitation hardenable nickel base alloy in accordance with BS2 HR 501 (equivalent specifications W.NR 2.4632, UNS N07090).

Nimonic 90 is suitable for operation in temperatures ranging from -100°C to +650° degrees celsius. Insert Material Max. Temp.

Typical Applications	Coatings		Max. Temp.
	Peak	Cont.	
Stainless 304	425°C 800°F	315°C 600°F	Most general applications in all materials FL, AG, CD
Stainless 316 FL, AG, CD	425°C 800°F	315°C 600°F	Increased corrosion resistance for salt water applications FL, AG, CD
Phosphor Bronze AG, CD	300°C 572°F	235°C 455°F	Copper parts, non-magnetic, low permeability applications
Inconel X-750 AG	650°C 1200°F	550°C 1020°F	Aerospace, turbines, corrosive environments, high temp. use
Nimonic 90	650°C 1200°F	550°C 1020°F	Aerospace and turbine applications AG

ALTERNATIVE FINISHES & COATINGS

Cadmium Plate

Electro-deposited Cadmium in accordance with DTD 904/Def Stan 03-19 (equivalent specifications FED. QQ-P-416, LN 9368). Cadmium plating provides an excellent barrier between dissimilar metals dramatically reducing the effects of galvanic corrosion, its high lubricity and excellent corrosion resistance prevents seizure and galling between threaded components. Cadmium plate is suitable for operation in temperatures ranging from -200°C to +235°C.

Cadmium plated parts must not be

- subjected to temperatures exceeding 235°C (455°F)
- come into contact with fuel or hot oil
- come into contact with food or drinking water
- be used with titanium components (either directly or indirectly). At elevated temperatures embrittlement and subsequent component failure may occur.
- Cadmium is highly toxic – consequently extreme care must be taken when shipping, handling and installing.

Zinc Plate

Electrolytically deposited zinc in accordance with BS 3382. Electro-deposited zinc is the most widely applied electroplated finish in industry. Zinc is suitable for operation in temperatures ranging from -200°C to +250°C.

Silver Plate

Electrolytically deposited silver in accordance with DTD 939. Silver plating is used to prevent seizure and galling between thread components in high temperature applications and is most commonly applied to aero-engine fasteners. Silver plate is suitable for operation in temperatures ranging from -200°C to +650°C. Silver plated wire inserts may be installed in various materials including aluminum alloys, magnesium alloys, corrosion and heat resistant materials etc. Silver plated inserts are not recommended for installation in titanium alloy which may exceed a service temperature of 300°C (570°F). Stress corrosion as a result of the combination of silver and titanium may occur in the housing material.

Dry Film Lubricant

Solid film heat cured molybdenum disulphide dry film lubricant coating in accordance with MIL-L-0046010 provides a low frictional coefficient coating with excellent load bearing capabilities. Dry film lubricant prevents seizing and galling between threaded components and is particularly effective in screw locking insert applications. Dry film lubricant is suitable for operation in temperatures ranging from -100°C to +250°C.

Plating / Finish Specification	Part No. Suffix	Applicable Process
Silver Plating	AG	DTD 939
Cadmium Plating	CD	QQP-416 or DEF STD 03-19
Dry Film Lubricant	FL	MIL-L-8937 or MIL-L-46010
Red Dye	–	Applied to locking inserts for identification purposes*

* other color dyes may also be utilised for specific identification purposes

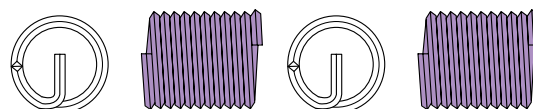

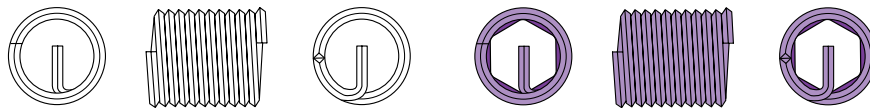

SELECTION OF CORRECT INSERT LENGTH

PowerCoil wire thread inserts are available in all popular thread types. Five insert lengths are available for each thread size. It is important to select the correct insert length in order to balance the bolt tensile strength against the shear strength of the parent material. The five insert lengths (recommended thread engagement of the PowerCoil wire thread insert), 1D, 1.5D, 2D, 2.5D and 3D are shown in the shaded area of the table below. These are calculated numbers since the inserts cannot be measured in the free (un-installed) state. The numbers are multiples of the nominal thread size, or diameter, of the insert. The actual insert lengths in the installed position are listed in the insert selection tables. There they represent the actual installed length plus 1/2 pitch. Using the table below, an insert length can be selected which will produce a thread system strong enough to fracture a bolt before it will strip or damage either the parent material or the insert.

Recommended Nominal Insert lengths Based on Parent Material Versus Bolt Material Strengths

UNIFIED (source BS7752 Part 1:1994)

Shear Strength of Parent Material (KSI)	Bolt Material Minimum Ultimate Tensile Strength (KSI)								
	54	75	96	108	125	132	160	180	220
10	2.0	2.5	3.0	3.0	-	-	-	-	-
15	1.5	1.5	2.0	2.5	2.5	3.0	-	-	-
20	1.0	1.5	1.5	2.0	2.0	2.0	2.5	3.0	3.0
25	1.0	1.0	1.5	1.5	1.5	2.0	2.0	2.5	2.5
30	1.0	1.0	1.0	1.5	1.5	1.5	2.0	2.0	2.5
40	1.0	1.0	1.0	1.0	1.0	1.5	1.5	1.5	2.0
50	1.0	1.0	1.0	1.0	1.0	1.0	1.0	1.5	1.5

EXAMPLE: If parent material shear strength is 10KSI and the bolt tensile strength is 54 KSI, the correct insert length is 2.0 diameters (2D).

METRIC

Shear Strength of Parent Material (MPa)	Bolt Material Minimum Ultimate Tensile Strength (MPa)								
	300	400	500	600	800	1000	1200	1400	
70	1.5	2.0	2.5	2.5	-	-	-	-	-
100	1.0	1.5	1.5	2.0	2.5	3.0	-	-	-
150	1.0	1.0	1.5	1.5	2.0	2.0	2.5	3.0	
200	1.0	1.0	1.0	1.0	1.5	1.5	2.0	2.5	
250	1.0	1.0	1.0	1.0	1.0	1.5	1.5	2.0	
300	1.0	1.0	1.0	1.0	1.0	1.5	1.5	1.5	
350	1.0	1.0	1.0	1.0	1.0	1.0	1.0	1.5	1.5

EXAMPLE: If parent material shear strength is 150Mpa and the bolt tensile strength is 600Mpa, the correct insert length is 1.5 diameters (1.5D).

BOLT PROJECTION

PowerCoil wire thread inserts are designed to be used with standard, readily available bolts and screws that require no special hardware.

The bolt must engage the entire insert length to achieve maximum assembly strength. To ensure against partial engagement, it is recommended that the tang always be removed. This will also guarantee that the locking coil(s) will be engaged by the full threads of the bolt. If design parameters prevent this, contact PowerCoil for assistance.

NOTES:

1. Bolt tensile strengths are specified minimums. When choosing an insert length, consideration should be given the maximum tensile strength allowed by the bolt drawing or procurement specification.
2. Service temperatures can cause significant variations in strength values, therefore compensation should be allowed.
3. The importance of shear values should be kept in mind because the parent material is subject to shear ing stress near the major diameter of the threads.
4. When the strength values fall between two values in the tables, use next lower material shear value, or the next higher bolt tensile strength value.
5. To achieve maximum strength, bolt length and thread length as well as full tapped thread depth must be sufficient to assure full thread engagement over the entire length of the insert.

SCREW LOCKING (PREVAILING TORQUE) INSERTS

Screw Locking PowerCoil wire thread inserts are designed for applications subject to the effects of cyclic vibration or impact. The screw locking insert exerts a prevailing torque on male threaded fasteners to prevent loosening due to vibration or impact. They eliminate the need for other, less desirable and costly locking mechanisms. They are excellent in "adjusting screw" applications by preventing the male fastener from creeping.

HOW SCREW LOCKING INSERTS WORK

PowerCoil Screw Locking inserts offer the additional security of prevailing locking torque. This is achieved by the action of one or more polygonal grip coils positioned within the insert's length, which exert radial pressure on the male thread. Each grip coil consists of a number of tangential locking chords which protrude inside the minor diameter of the normal free running coils. As the male thread passes through these grip coils, the locking flats are displaced and exert radial pressure (prevailing torque) on the male thread.

On removal of the male thread, the locking coils relax to their original form permitting repeated assembly while retaining a measurable level of prevailing torque.

Please note:

It is recommended that only close fit plated or lubricated bolts or screws are used with screw locking PowerCoil wire thread inserts. When using heat treated unplated or stainless steel bolts, an anti-seize compound, e.g., molybdenum disulfide, must be used in order to minimize galling and assure maximum cycle life. Wear life of screw or bolt using PowerCoil screw locking wire thread inserts can also be improved by specifying dry film lubrication or cadmium plating.

LOCATION OF LOCKING COILS

For 1D, 1.5D, and 2D diameter lengths: The center of the locking coil (or coils) equals 1/2 the number of free coils. For 2.5D and 3D diameter lengths: The locking coil is located the same distance from the tang as 2D length inserts.

Screw locking inserts are dyed red for easy identification purposes only. It is alcohol soluble and can be removed if desired.

RED DYE COATING

PowerCoil screw locking inserts are generally colour coded with an organic red dye for identification purposes. The dye does not affect

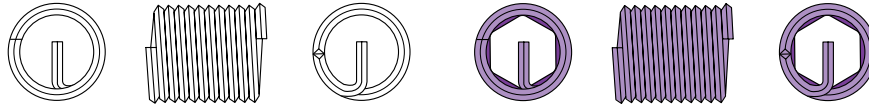

the installation or performance of the insert and does not need to be removed (in most situations). In situations requiring extreme cleanliness (such as assembly of precision instruments in clean room conditions) the dye may be removed by soaking the inserts in a denatured alcohol solution prior to installation.

Note: It is also essential that the bolt fully engages all insert coils for maximum strength.

PowerCoil screw locking inserts can be designed to suit a customer's specific needs. In certain instances and applications prevailing torque can be lessened or increased to cater for a specific application. In these situations please contact your PowerCoil representative to discuss your specific requirements.

Please Note: Installation of PowerCoil screw locking inserts requires the use of a pre-winder tool. Please discuss other installation options with your PowerCoil agent.

POWERCOIL LOCKING INSERT TORQUE VALUES

METRIC COARSE		
Thread mm x mm	Torque Max (Nm)	Torque Min (Nm)
M2.2x0.45	0.14	0.02
M2.5x0.45	0.23	0.05
M3.0x0.50	0.45	0.10
M3.5x0.60	0.68	0.12
M4.0x0.70	0.90	0.15
M5.0x0.80	1.60	0.30
M6.0x1.00	3.00	0.40
M7.0x1.00	4.50	0.60
M8.0x1.25	6.00	0.80
M10.0x1.50	10.50	1.40
M12.0x1.75	15.50	2.10
M14.0x2.00	23.50	3.00
M16.0x2.00	31.50	4.20
M18.0x2.50	42.00	5.50
M20.0x2.50	54.00	7.00
M22.0x2.50	67.50	9.00
M24.0x3.00	80.00	10.50
M27.0x3.00	94.00	12.00
M30.0x3.50	108.00	14.00
M33.0x3.50	122.00	15.50
M36.0x4.00	136.00	17.50
M39.0x4.00	150.00	19.50

METRIC FINE		
Thread mm x mm	Torque Max (Nm)	Torque Min (Nm)
M8.0x1.00	6.00	0.80
M10.0x1.00	10.50	1.40
M10.0x1.25	10.50	1.40
M12.0x1.25	15.50	2.10
M12.0x1.50	15.50	2.10
M14.0x1.50	23.50	3.00
M16.0x1.50	31.50	4.20
M18.0x1.50	42.00	5.50
M20.0x1.50	54.00	7.00
M22.0x1.50	67.50	9.00
M18.0x2.00	42.00	5.50
M20.0x2.00	54.00	7.00
M22.0x2.00	67.50	9.00
M24.0x2.00	80.00	10.50
M27.0x2.00	94.00	12.00
M30.0x2.00	108.00	14.00
M33.0x2.00	122.00	15.50
M36.0x2.00	136.00	17.50
M39.0x2.00	150.00	19.50
M36.0x3.00	136.00	17.50
Locking torque values conform to MA3329, MA3330, MA3331		

UNIFIED NATIONAL COARSE – UNC		
Thread inch x tpi	Torque Max (lb in)	Torque Min (lb in)
2x56	1.25	0.19
3x48	2.00	0.44
4x40	3.00	0.63
5x40	4.69	0.81
6x32	6.00	1.00
8x32	9.00	1.50
10x24	13.00	2.00
12x24	24.00	3.00
1/4x20	30.00	4.50
5/16x18	60.00	7.50
3/8x18	80.00	12.00
7/16x14	100.00	16.50
1/2x13	150.00	24.00
9/16x12	200.00	30.00
5/8x11	300.00	40.00
3/4x10	400.00	60.00
7/8x9	600.00	82.00
1x8	800.00	110.00
1.1/8x7	900.00	137.00
1.1/4x7	1000.00	165.00
1.3/8x6	1150.00	185.00
1.1/2x6	1350.00	210.00

UNIFIED NATIONAL FINE – UNF		
Thread inch x tpi	Torque Max (lb in)	Torque Min (lb in)
3x56	0.13	0.44
4x48	0.19	0.63
6x40	6.00	1.00
8x36	9.00	1.50
10x32	13.00	2.00
1/4x28	30.00	3.50
5/16x24	60.00	6.50
3/8x24	80.00	9.50
7/16x20	100.00	14.00
1/2x20	150.00	18.00
9/16x18	200.00	24.00
5/8x18	300.00	32.00
3/4x16	400.00	50.00
7/8x14	600.00	70.00
1x12	800.00	90.00
1.1/8x12	900.00	117.00
1.1/4x12	1000.00	143.00
1.3/8x12	1150.00	165.00
1.1/2x12	1350.00	190.00
Locking torque values conform to NASM8846		



Metric Coarse

GROUP	PCRK
INSERT TYPE	WIRE THREAD
INSERT MATERIAL	304 STAINLESS STEEL
STYLE	FREE RUNNING



MC



IMPORTANT

It is recommended that when repairing the thread on spark plug ports that you remove the head.

If you do not remove the head it is essential that you protect the engine from the ingress of chips and swarf generated by the tapping process.

METRIC COARSE

MM	MM	INSTALLED LENGTH	PART #	#	MM	PART #	PART #	PART #	
2.00	0.40	1.5D	3.00MM	3520-2.00K	20	2.1	3520-2.00I	3500-HIT2	3500-TB1
2.20	0.45	1.5D	3.30MM	3520-2.20K	20	2.3	3520-2.20I	3500-HIT2	3500-TB2
2.50	0.45	1.5D	3.75MM	3520-2.50K	20	2.6	3520-2.50I	3500-HIT3	3500-TB3
3.00	0.50	1.5D	4.50MM	3520-3.00K	20	3.2	3520-3.00I	3500-HIT4	3500-TB4
3.50	0.60	1.5D	5.25MM	3520-3.50K	20	3.7	3520-3.50I	3500-HIT5	3500-TB5
4.00	0.70	1.5D	6.00MM	3520-4.00K	20	4.2	3520-4.00I	3500-HIT6	3500-TB6
5.00	0.80	1.5D	7.50MM	3520-5.00K	20	5.2	3520-5.00I	3500-HIT8	3500-TB8
6.00	1.00	1.5D	9.00MM	3520-6.00K	20	6.3	3520-6.00I	3500-HIT9	3500-TB9
7.00	1.00	1.5D	10.50MM	3520-7.00K	20	7.3	3520-7.00I	3500-HIT10	3500-TB11
8.00	1.25	1.5D	12.00MM	3520-8.00K	20	8.3	3520-8.00I	3500-HIT11	3500-TB12
9.00	1.25	1.5D	13.50MM	3520-9.00K	15	9.4	3520-9.00I	3500-HIT13	3500-TB12
10.00	1.50	1.5D	15.00MM	3520-10.00K	15	10.4	3520-10.00I	3500-HIT13	3500-TB13
11.00	1.50	1.5D	16.50MM	3520-11.00K	10	11.4	3520-11.00I	3500-HIT14	3500-TB14
12.00	1.75	1.5D	18.00MM	3520-12.00K	10	12.4	3520-12.00I	3500-HIT15	3500-TB15
13.00	1.75	1.5D	19.50MM	3520-13.00K	10	13.5*	3520-13.00I	3500-HIT15	-
14.00	2.00	1.5D	21.00MM	3520-14.00K	10	14.5*	3520-14.00I	3500-HIT16	-
15.00	2.00	1.5D	22.50MM	3520-15.00K	10	15.5*	3520-15.00I	3500-HIT16	-
16.00	2.00	1.5D	24.00MM	3520-16.00K	10	16.5*	3520-16.00I	3500-HIT18	-
18.00	2.50	1.5D	27.00MM	3520-18.00K	5	18.5*	3520-18.00I	3500-HIT20	-
20.00	2.50	1.5D	30.00MM	3520-20.00K	5	20.8*	3520-20.00I	3500-HIT21	-
22.00	2.50	1.5D	33.00MM	3520-22.00K	5	22.8*	3520-22.00I	3500-HIT22	-
24.00	3.00	1.5D	36.00MM	3520-24.00K	5	25.0*	3520-24.00I	3500-HIT23	-
27.00	3.00	1.5D	40.50MM	3520-27.00K	5	28.0*	3520-27.00I	3500-HIT24	-
30.00	3.50	1.5D	45.00MM	3520-30.00K	5	31.0*	3520-30.00I	3500-HIT25	-
33.00	3.50	1.5D	49.50MM	3520-33.00K	5	34.0*	3520-33.00I	3500-HIT26	-
36.00	4.00	1.5D	54.00MM	3520-36.00K	5	37.0*	3520-36.00I	3500-HIT28	-

* Tapping drill not included in thread repair kit.

SPARK PLUG

MM	MM	INSTALLED LENGTH	PART #	#	MM	PART #	PART #	PART #	
10.00	1.00	-	1/2"	3522-10.00K	5	-	3522-10.00PN	3500-HIT13	3500-TB13
-	-	-	0.339"	-	5	-	-	-	-
12.00	1.25	-	1/2"	3522-12.00K	5	-	3522-10.00PN	3500-HIT15	3500-TB15
-	-	-	3/4"	-	5	-	-	-	-
14.00	1.25	-	3/8"	3522-14.00K	5	-	3522-14.00PN	3500-HIT17	-
-	-	-	1/2"	-	5	-	-	-	-
-	-	-	3/4"	-	5	-	-	-	-
14.00	1.25	8.4MM	-	3522-14.00K1	5	-	3522-14.00PN	3500-HIT17	-
-	-	-	-	-	5	-	-	-	-
-	-	-	-	-	5	-	-	-	-
18.00	1.50	-	1/2"	3522-18.00K	5	-	3522-18.00PN	3500-HIT20	-

STI Pilot Nose Taps are used to repair damaged threads and do not require the drilling of a pilot hole.

These taps use the existing thread as a guide in tapping a straight hole. STI Pilot Nose Taps are most commonly used to tap holes for the repair of spark plug threads.





GROUP	PCRK
INSERT TYPE	WIRE THREAD
INSERT MATERIAL	304 STAINLESS STEEL
STYLE	FREE RUNNING



METRIC FINE									
MM	MM	INSTALLED LENGTH	PART #	#	MM	PART #	PART #	PART #	PART #
8.00	1.00	1.5D	12.00MM	3521-8.00K	20	8.3	3521-8.00I	3500-HIT11	3500-TB12
10.00	1.25	1.5D	15.00MM	3521-10.00K	15	10.3	3521-10.00I	3500-HIT13	3500-TB13
10.00	1.00	1.5D	15.00MM	3523-10.00K	15	10.3	3523-10.00I	3500-HIT13	3500-TB13
11.00	1.25	1.5D	16.50MM	3521-11.00K	10	11.3	3521-11.00I	3500-HIT14	3500-TB14
11.00	1.00	1.5D	16.50MM	3523-11.00K	10	11.3	3523-11.00I	3500-HIT14	3500-TB14
12.00	1.50	1.5D	18.00MM	3521-12.00K	10	12.4	3521-12.00I	3500-HIT15	3500-TB15
12.00	1.25	1.5D	18.00MM	3523-12.00K	10	12.3	3523-12.00I	3500-HIT15	3500-TB15
12.00	1.00	1.5D	18.00MM	3524-12.00K	10	12.3	3524-12.00I	3500-HIT15	3500-TB15
13.00	1.50	1.5D	19.50MM	3521-13.00K	10	13.2*	3521-13.00I	3500-HIT15	-
13.00	1.25	1.5D	19.50MM	3523-13.00K	10	13.2*	3523-13.00I	3500-HIT15	-
14.00	1.50	1.5D	21.00MM	3521-14.00K	10	14.4*	3521-14.00I	3500-HIT16	-
14.00	1.25	1.5D	21.00MM	3523-14.00K	10	14.3*	3523-14.00I	3500-HIT16	-
14.00	1.00	1.5D	21.00MM	3524-14.00K	10	14.3*	3524-14.00I	3500-HIT16	-
15.00	1.50	1.5D	22.50MM	3521-15.00K	10	15.3*	3521-15.00I	3500-HIT16	-
16.00	1.50	1.5D	24.00MM	3521-16.00K	10	16.5*	3521-16.00I	3500-HIT18	-
18.00	2.00	1.5D	27.00MM	3521-18.00K	5	18.5*	3521-18.00I	3500-HIT20	-
18.00	1.50	1.5D	27.00MM	3523-18.00K	5	18.5*	3523-18.00I	3500-HIT20	-
20.00	2.00	1.5D	30.00MM	3521-20.00K	5	20.5*	3521-20.00I	3500-HIT21	-
20.00	1.50	1.5D	30.00MM	3523-20.00K	5	20.5*	3523-20.00I	3500-HIT21	-
22.00	2.00	1.5D	33.00MM	3521-22.00K	5	22.5*	3521-22.00I	3500-HIT22	-
22.00	1.50	1.5D	33.00MM	3523-22.00K	5	22.5*	3523-22.00I	3500-HIT22	-
24.00	2.00	1.5D	36.00MM	3521-24.00K	5	24.5*	3521-24.00I	3500-HIT23	-
24.00	1.50	1.5D	36.00MM	3523-24.00K	5	24.5*	3523-24.00I	3500-HIT23	-
26.00	1.50	1.5D	39.00MM	3523-26.00K	5	26.5*	3523-26.00I	3500-HIT24	-
27.00	2.00	1.5D	40.50MM	3521-27.00K	5	27.5*	3521-27.00I	3500-HIT24	-
27.00	1.50	1.5D	40.50MM	3523-27.00K	5	27.5*	3523-27.00I	3500-HIT24	-
28.00	1.50	1.5D	42.00MM	3523-28.00K	5	28.5*	3523-28.00I	3500-HIT24	-
30.00	2.00	1.5D	45.00MM	3521-30.00K	5	30.5*	3521-30.00I	3500-HIT26	-
30.00	1.50	1.5D	45.00MM	3523-30.00K	5	30.5*	3523-30.00I	3500-HIT26	-
33.00	2.00	1.5D	49.50MM	3521-33.00K	5	33.5*	3521-33.00I	3500-HIT26	-
36.00	3.00	1.5D	54.00MM	3521-36.00K	3	37.0*	3521-36.00I	3500-HIT28	-
36.00	2.00	1.5D	54.00MM	3523-36.00K	3	36.5*	3523-36.00I	3500-HIT28	-
36.00	1.50	1.5D	54.00MM	3524-36.00K	3	36.5*	3524-36.00I	3500-HIT28	-



MF
Standard Bolt

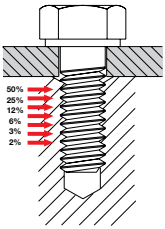

Bolt with PowerCoil insert

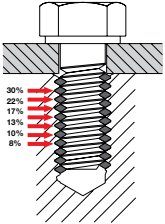

In a conventional threaded joint 75% of the load is placed on the first three threads.

The helical coil design of the PowerCoil Wire Thread Insert allows the shear loading to be transformed into a more desirable radial loading (hoop stress) over the entire length of the insert.

Use of a PowerCoil insert results in a far stronger thread than can be obtained by using conventional drilling or tapping. Improved strength allows designers to select fasteners based on minimum bolt strength and allows the use of smaller diameters and thread lengths - even in magnesium and aluminum alloys.

* Tapping drill not included in thread repair kit.



Bulk Free Running Inserts
Page 22



UNC, UNF

GROUP	PCRK
INSERT TYPE	WIRE THREAD
INSERT MATERIAL	304 STAINLESS STEEL
STYLE	FREE RUNNING



UNC
UNF

UNC

INCH	TPI	INSTALLED LENGTH	PART #	#	MM	PART #	PART #	PART #
2G	56	1.5D 0.13"	3532-2GK	20	2.4	3532-2GI	3500-HIT2	3500-TB2
3G	48	1.5D 0.15"	3532-3GK	20	2.7	3532-3GI	3500-HIT3	3500-TB3
4G	40	1.5D 0.17"	3532-4GK	20	3.1	3532-4GI	3500-HIT4	3500-TB4
5G	40	1.5D 0.19"	3532-5GK	20	3.4	3532-5GI	3500-HIT4	3500-TB4
6G	32	1.5D 0.21"	3532-6GK	20	3.8	3532-6GI	3500-HIT5	3500-TB5
8G	32	1.5D 0.25"	3532-8GK	20	4.4	3532-8GI	3500-HIT6	3500-TB6
10G	24	1.5D 0.28"	3532-10GK	20	5.2	3532-10GI	3500-HIT7	3500-TB8
12G	24	1.5D 0.33"	3532-12GK	20	5.8	3532-12GI	3500-HIT8	3500-TB8
1/4	20	1.5D 0.38"	3532-1/4K	20	6.7	3532-1/4I	3500-HIT9	3500-TB9
5/16	18	1.5D 0.47"	3532-5/16K	20	8.3	3532-5/16I	3500-HIT10	3500-TB12
3/8	16	1.5D 0.56"	3532-3/8K	15	9.9	3532-3/8I	3500-HIT13	3500-TB12
7/16	14	1.5D 0.66"	3532-7/16K	10	11.6	3532-7/16I	3500-HIT14	3500-TB14
1/2	13	1.5D 0.75"	3532-1/2K	10	13.0	3532-1/2I	3500-HIT15	3500-TB15
9/16	12	1.5D 0.84"	3532-9/16K	10	15.0*	3532-9/16I	3500-HIT16	-
5/8	11	1.5D 0.94"	3532-5/8K	10	16.5*	3532-5/8I	3500-HIT18	-
3/4	10	1.5D 1.13"	3532-3/4K	5	19.8*	3532-3/4I	3500-HIT20	-
7/8	9	1.5D 1.31"	3532-7/8K	5	23.0*	3532-7/8I	3500-HIT22	-
1	8	1.5D 1.50"	3532-1K	5	26.2*	3532-1I	3500-HIT23	-
1-1/8	7	1.5D 1.69"	3532-1.1/8K	3	29.5*	3532-1.1/8I	3500-HIT25	-
1-1/4	7	1.5D 1.88"	3532-1.1/4K	3	32.5*	3532-1.1/4I	3500-HIT26	-
1-3/8	6	1.5D 2.06"	3532-1.3/8K	3	36.0*	3532-1.3/8I	3500-HIT27	-
1-1/2	6	1.5D 2.25"	3532-1.1/2K	3	39.5*	3532-1.1/2I	3500-HIT28	-

UNF

INCH	TPI	INSTALLED LENGTH	PART #	#	MM	PART #	PART #	PART #
3G	56	1.5D 0.15"	3534-3GK	20	2.7	3534-3GI	3500-HIT3	3500-TB3
4G	48	1.5D 0.17"	3534-4GK	20	3.0	3534-4GI	3500-HIT4	3500-TB4
6G	40	1.5D 0.21"	3534-6GK	20	3.8	3534-6GI	3500-HIT5	3500-TB5
8G	36	1.5D 0.25"	3534-8GK	20	4.4	3534-8GI	3500-HIT6	3500-TB6
10G	32	1.5D 0.28"	3534-10GK	20	5.1	3534-10GI	3500-HIT8	3500-TB8
12G	28	1.5D 0.33"	3534-12GK	20	5.6	3534-12GI	3500-HIT8	3500-TB8
1/4	28	1.5D 0.38"	3534-1/4K	20	6.7	3534-1/4I	3500-HIT9	3500-TB9
5/16	24	1.5D 0.47"	3534-5/16K	20	8.3	3534-5/16I	3500-HIT11	3500-TB12
3/8	24	1.5D 0.56"	3534-3/8K	15	9.8	3534-3/8I	3500-HIT13	3500-TB13
7/16	16	1.5D 0.66"	3534-7/16-16K	10	11.5	3534-7/16-16I	3500-HIT14	3500-TB14
7/16	20	1.5D 0.66"	3534-7/16K	10	11.5	3534-7/16I	3500-HIT14	3500-TB14
1/2	20	1.5D 0.75"	3534-1/2K	10	13.0	3534-1/2I	3500-HIT15	3500-TB15
9/16	18	1.5D 0.84"	3534-9/16K	10	14.7*	3534-9/16I	3500-HIT16	-
5/8	18	1.5D 0.94"	3534-5/8K	10	16.3*	3534-5/8I	3500-HIT18	-
3/4	16	1.5D 1.13"	3534-3/4K	5	19.5*	3534-3/4I	3500-HIT21	-
7/8	14	1.5D 1.31"	3534-7/8K	5	22.5*	3534-7/8I	3500-HIT22	-
1	12	1.5D 1.50"	3534-1K	5	26.0*	3534-1I	3500-HIT23	-
1	14	1.5D 1.50"	3535-1K	5	26.0*	3535-1I	3500-HIT23	-
1-1/8	12	1.5D 1.69"	3534-1.1/8K	3	29.5*	3534-1.1/8I	3500-HIT25	-
1-1/4	12	1.5D 1.88"	3534-1.1/4K	3	32.5*	3534-1.1/4I	3500-HIT26	-
1-3/8	12	1.5D 2.06"	3534-1.3/8K	3	35.5*	3534-1.3/8I	3500-HIT27	-
1-1/2	12	1.5D 2.25"	3534-1.1/2K	3	38.5*	3534-1.1/2I	3500-HIT28	-

* Tapping drill not included in thread repair kit.



**BSW
BSF
BSP**

GROUP	PCRK
INSERT TYPE	WIRE THREAD
INSERT MATERIAL	304 STAINLESS STEEL
STYLE	FREE RUNNING

BSW									
INCH	TPI	INSTALLED LENGTH		PART #	#	MM	PART #	PART #	PART #
1/8	40	1.5D	0.19"	3528-1/8K	20	3.4	3528-1/8I	3500-HIT4	3500-TB4
3/16	24	1.5D	0.28"	3528-3/16K	20	5.0	3528-3/16I	3500-HIT7	3500-TB8
1/4	20	1.5D	0.38"	3528-1/4K	20	6.7	3528-1/4I	3500-HIT9	3500-TB9
5/16	18	1.5D	0.47"	3528-5/16K	20	8.3	3528-5/16I	3500-HIT10	3500-TB11
3/8	16	1.5D	0.56"	3528-3/8K	15	9.9	3528-3/8I	3500-HIT11	3500-TB12
7/16	14	1.5D	0.66"	3528-7/16K	10	11.5	3528-7/16I	3500-HIT14	3500-TB14
1/2	12	1.5D	0.75"	3528-1/2K	10	13.0	3528-1/2I	3500-HIT15	3500-TB15
9/16	12	1.5D	0.84"	3528-9/16K	10	14.8*	3528-9/16I	3500-HIT16	-
5/8	11	1.5D	0.94"	3528-5/8K	10	16.7*	3528-5/8I	3500-HIT18	-
3/4	10	1.5D	1.13"	3528-3/4K	5	20.0*	3528-3/4I	3500-HIT20	-
7/8	9	1.5D	1.31"	3528-7/8K	5	23.2*	3528-7/8I	3500-HIT22	-
1	8	1.5D	1.50"	3528-1K	5	26.5*	3528-1I	3500-HIT23	-

BSF									
INCH	TPI	INSTALLED LENGTH		PART #	#	MM	PART #	PART #	PART #
3/16	32	1.5D	0.28"	3530-3/16K	20	5.0	3530-3/16I	3500-HIT8	3500-TB6
1/4	26	1.5D	0.38"	3530-1/4K	20	6.6	3530-1/4I	3500-HIT9	3500-TB9
5/16	22	1.5D	0.47"	3530-5/16K	20	8.3	3530-5/16I	3500-HIT11	3500-TB11
3/8	20	1.5D	0.56"	3530-3/8K	15	9.9	3530-3/8I	3500-HIT13	3500-TB12
7/16	18	1.5D	0.66"	3530-7/16K	10	11.5	3530-7/16I	3500-HIT14	3500-TB14
1/2	16	1.5D	0.75"	3530-1/2K	10	13.0	3530-1/2I	3500-HIT15	3500-TB15
9/16	16	1.5D	0.84"	3530-9/16K	10	14.8*	3530-9/16I	3500-HIT16	-
5/8	14	1.5D	0.94"	3530-5/8K	10	16.3*	3530-5/8I	3500-HIT18	-
3/4	12	1.5D	1.13"	3530-3/4K	5	19.5*	3530-3/4I	3500-HIT20	-
7/8	11	1.5D	1.31"	3530-7/8K	5	22.8*	3530-7/8I	3500-HIT22	-
1	10	1.5D	1.50"	3530-1K	5	26.2*	3530-1I	3500-HIT23	-

BSP									
INCH	TPI	INSTALLED LENGTH		PART #	#	MM	PART #	PART #	PART #
1/8	28	1.5D	0.19"	3546-1/8K	10	10.0*	3546-1/8I	3500-HIT14	-
1/4	19	1.5D	0.38"	3546-1/4K	10	13.6*	3546-1/4I	3500-HIT16	-
3/8	19	1.5D	0.56"	3546-3/8K	10	17.1*	3546-3/8I	3500-HIT20	-
1/2	14	1.5D	0.75"	3546-1/2K	10	21.5*	3546-1/2I	3500-HIT23	-
5/8	14	1.5D	0.94"	3546-5/8K	10	23.4*	3546-5/8I	3500-HIT23	-
3/4	14	1.5D	1.13"	3546-3/4K	10	27.0*	3546-3/4I	3500-HIT24	-
7/8	14	1.5D	1.31"	3546-7/8K	5	30.5*	3546-7/8I	3500-HIT27	-
1	11	1.5D	1.50"	3546-1K	5	33.7*	3546-1I	3500-HIT27	-

* Tapping drill not included in thread repair kit.



NPT, 8-UN, BSC, BA

BSC, BA

GROUP	PCRK
INSERT TYPE	WIRE THREAD
INSERT MATERIAL	304 STAINLESS STEEL
STYLE	FREE RUNNING



NPT
8-UN
BSC
BA

NPT

INCH	TPI	INSTALLED LENGTH	PART #	#	MM	PART #	PART #	PART #
1/16	27	1.5D 0.09"	3552-1/16K	10	K*	3552-1/16I	3500-HIT10	-
1/8	27	1.5D 0.19"	3552-1/8K	10	U*	3552-1/8I	3500-HIT13	-
1/4	18	1.5D 0.38"	3552-1/4K	10	31/64*	3552-1/4I	3500-HIT16	-
3/8	18	1.5D 0.56"	3552-3/8K	10	5/8*	3552-3/8I	3500-HIT18	-
1/2	14	1.5D 0.75"	3552-1/2K	10	35/32*	3552-1/2I	3500-HIT22	-
3/4	14	1.5D 1.13"	3552-3/4K	10	63/64*	3552-3/4I	3500-HIT24	-
1	11.5	1.5D 1.50"	3552-1K	10	1-1/4*	3552-1I	3500-HIT27	-

8-UN

INCH	TPI	INSTALLED LENGTH	PART #	#	MM	PART #	PART #	PART #
1-1/8	8	1.5D 1.69"	3570-1.1/8K	3	28.5*	3570-1.1/8I	3500-HIT25	-
1-1/4	8	1.5D 1.88"	3570-1.1/4K	3	32.0*	3570-1.1/4I	3500-HIT26	-
1-3/8	8	1.5D 2.06"	3570-1.3/8K	3	35.0*	3570-1.3/8I	3500-HIT27	-
1-1/2	8	1.5D 2.25"	3570-1.1/2K	3	38.0*	3570-1.1/2I	3500-HIT28	-
1-5/8	8	1.5D 2.44"	3570-1.5/8K	3	41.0*	3570-1.5/8I	3500-HIT28	-
1-3/4	8	1.5D 2.63"	3570-1.3/4K	3	44.5*	3570-1.3/4I	3500-HIT28	-
1-7/8	8	1.5D 2.81"	3570-1.7/8K	3	47.5*	3570-1.7/8I	3500-HIT30	-
2	8	1.5D 3.00"	3570-2K	3	50.8*	3570-2I	3500-HIT30	-

BSC

INCH	TPI	INSTALLED LENGTH	PART #	#	MM	PART #	PART #	PART #
1/4	26	1.5D 0.38"	3560-1/4K	20	6.6	3560-1/4I	3500-HIT10	3500-TB9
5/16	26	1.5D 0.47"	3560-5/16K	20	8.0	3560-5/16I	3500-HIT11	3500-TB12
3/8	26	1.5D 0.56"	3560-3/8K	15	9.8	3560-3/8I	3500-HIT13	3500-TB13
7/16	26	1.5D 0.66"	3560-7/16K	10	11.1	3560-7/16I	3500-HIT14	3500-TB14
1/2	26	1.5D 0.75"	3560-1/2K	10	12.7	3560-1/2I	3500-HIT15	3500-TB15

BA

INCH	MM	INCH	INSTALLED LENGTH	PART #	#	MM	PART #	PART #	PART #
0	0.236	6.0	0.0394 1.5D 0.35"	3544-0K	20	6.2	3544-0I	3500-HIT9	3500-TB11
2	0.185	4.7	0.0319 1.5D 0.28"	3544-2K	20	4.9	3544-2I	3500-HIT7	3500-TB8
4	0.142	3.6	0.0260 1.5D 0.21"	3544-4K	20	3.8	3544-4I	3500-HIT5	3500-TB5
6	0.110	2.8	0.0209 1.5D 0.17"	3544-6K	20	2.9	3544-6I	3500-HIT3	3500-TB3

* Tapping drill not included in thread repair kit.



MC
MF

GROUP	PCRK
INSERT TYPE	WIRE THREAD
INSERT MATERIAL	304 STAINLESS
STYLE	FREE RUNNING

METRIC COARSE M5-M12

MM	MM	INSTALLED LENGTH		PART #	#	MM	PART #	PART #	PART #
5.00	0.80	1.5D	7.5MM	3520-WK1	25	5.2	3520-5.00I	3500-HIT8	3500-TB8
6.00	1.00	1.5D	9.0MM		25	6.3	3520-6.00I	3500-HIT9	3500-TB9
8.00	1.25	1.5D	12.0MM		25	8.3	3520-8.00I	3500-HIT11	3500-TB12
10.00	1.50	1.5D	15.0MM		25	10.4	3520-10.00I	3500-HIT13	3500-TB13
12.00	1.75	1.5D	18.0MM		10	12.4	3520-12.00I	3500-HIT15	3500-TB15

METRIC COARSE M6-M12 + M14 SPARK PLUG

MM	MM	INSTALLED LENGTH		PART #	#	MM	PART #	PART #	PART #
6.00	1.00	1.5D	9.0MM	3522-WK4	25	6.3	3520-6.00I	3500-HIT9	3500-TB9
8.00	1.25	1.5D	12.0MM		25	8.3	3520-8.00I	3500-HIT11	3500-TB12
10.00	1.50	1.5D	15.0MM		25	10.4	3520-10.00I	3500-HIT13	3500-TB13
12.00	1.75	1.5D	18.0MM		10	12.4	3520-12.00I	3500-HIT15	3500-TB15
14.00	1.25	-	8.4MM		5	-	3522-14.00PN	3500-HIT17	-
14.00	1.25	-	12.4MM		5	-	-	-	-
14.00	1.25	-	16.4MM		5	-	-	-	-

SPARK PLUG

MM	MM	INSTALLED LENGTH		PART #	#	MM	PART #	PART #	PART #
10.00	1.00	-	0.339"	3522-WK1	5	-	3522-10.00PN	3500-HIT13	3500-TB13
-	-	-	1/2"		5	-	-	-	-
12.00	1.25	-	1/2"		5	-	3522-12.00PN	3500-HIT15	3500-TB15
-	-	-	3/4"		5	-	-	-	-
14.00	1.25	-	3/8"		5	-	3522-14.00PN	3500-HIT17	-
-	-	-	1/2"		5	-	-	-	-
-	-	-	3/4"		5	-	-	-	-





UNC, UNF, BSW, BSF

GROUP	PCRK
INSERT TYPE	WIRE THREAD
INSERT MATERIAL	304 STAINLESS
STYLE	FREE RUNNING



UNC
UNF
BSW
BSF

UNC 1/4" – UNC 1/2"

INCH	TPI	INSTALLED LENGTH		PART #	#	MM	PART #	PART #	PART #
1/4	20	1.5D	0.38"	3532-WK1	25	6.7	3532-1/4I	3500-HIT9	3500-TB9
5/16	18	1.5D	0.47"		25	8.3	3532-5/16I	3500-HIT10	3500-TB12
3/8	16	1.5D	0.56"		25	9.9	3532-3/8I	3500-HIT13	3500-TB12
7/16	14	1.5D	0.66"		10	11.6	3532-7/16I	3500-HIT14	3500-TB14
1/2	13	1.5D	0.75"		10	13.0	3532-1/2I	3500-HIT15	3500-TB15

UNF 1/4" – UNF 1/2"

INCH	TPI	INSTALLED LENGTH		PART #	#	MM	PART #	PART #	PART #
1/4	28	1.5D	0.38"	3534-WK1	25	6.7	3534-1/4I	3500-HIT9	3500-TB9
5/16	24	1.5D	0.47"		25	8.3	3534-5/16I	3500-HIT11	3500-TB12
3/8	24	1.5D	0.56"		25	9.8	3534-3/8I	3500-HIT13	3500-TB13
7/16	20	1.5D	0.66"		10	11.5	3534-7/16I	3500-HIT14	3500-TB14
1/2	20	1.5D	0.75"		10	13.0	3534-1/2I	3500-HIT15	3500-TB15

BSW 1/4" – BSW 1/2"

INCH	TPI	INSTALLED LENGTH		PART #	#	MM	PART #	PART #	PART #
1/4	20	1.5D	0.38"	3528-WK1	25	6.7	3528-1/4I	3500-HIT9	3500-TB9
5/16	18	1.5D	0.47"		25	8.3	3528-5/16I	3500-HIT10	3500-TB11
3/8	16	1.5D	0.56"		25	9.9	3528-3/8I	3500-HIT11	3500-TB12
7/16	14	1.5D	0.66"		10	11.5	3528-7/16I	3500-HIT14	3500-TB14
1/2	12	1.5D	0.75"		10	13.0	3528-1/2I	3500-HIT15	3500-TB15

BSF 1/4" – BSF 1/2"

INCH	TPI	INSTALLED LENGTH		PART #	#	MM	PART #	PART #	PART #
1/4	26	1.5D	0.38"	3530-WK1	25	6.6	3530-1/4I	3500-HIT9	3500-TB9
5/16	22	1.5D	0.47"		25	8.3	3530-5/16I	3500-HIT11	3500-TB11
3/8	20	1.5D	0.56"		25	9.9	3530-3/8I	3500-HIT13	3500-TB12
7/16	18	1.5D	0.66"		10	11.5	3530-7/16I	3500-HIT14	3500-TB14
1/2	16	1.5D	0.75"		10	13.0	3530-1/2I	3500-HIT15	3500-TB15



GROUP	PCRP
INSERT TYPE	WIRE THREAD
INSERT MATERIAL	304 STAINLESS STEEL
STYLE	FREE RUNNING



METRIC COARSE

MM	MM	INSTALLED LENGTH	#	PART #	PART #	PART #	PART #	PART #	PART #	PART #	PART #
2.00	0.40	1.0D	2.00MM	10	3520-2.00X1.0DP	-	-	-	-	-	-
2.00	0.40	1.5D	3.00MM	10	-	3520-2.00X1.5DP	-	-	-	-	-
2.00	0.40	2.0D	4.00MM	10	-	-	-	3520-2.00X2.0DP	-	-	-
2.20	0.45	1.0D	2.20MM	10	3520-2.20X1.0DP	-	-	-	-	-	-
2.20	0.45	1.5D	3.30MM	10	-	3520-2.20X1.5DP	-	-	-	-	-
2.20	0.45	2.0D	4.40MM	10	-	-	-	3520-2.20X2.0DP	-	-	-
2.50	0.45	1.0D	2.50MM	10	3520-2.50X1.0DP	-	-	-	-	-	-
2.50	0.45	1.5D	3.75MM	10	-	3520-2.50X1.5DP	-	-	-	-	-
2.50	0.45	2.0D	5.00MM	10	-	-	-	3520-2.50X2.0DP	-	-	-
3.00	0.50	1.0D	3.00MM	10	3520-3.00X1.0DP	-	-	-	-	-	-
3.00	0.50	1.5D	4.50MM	10	-	3520-3.00X1.5DP	-	-	-	-	-
3.00	0.50	2.0D	6.00MM	10	-	-	-	3520-3.00X2.0DP	-	-	-
3.50	0.60	1.0D	3.50MM	10	3520-3.50X1.0DP	-	-	-	-	-	-
3.50	0.60	1.5D	5.25MM	10	-	3520-3.50X1.5DP	-	-	-	-	-
3.50	0.60	2.0D	7.00MM	10	-	-	-	3520-3.50X2.0DP	-	-	-
4.00	0.70	1.0D	4.00MM	10	3520-4.00X1.0DP	-	-	-	-	-	-
4.00	0.70	1.5D	6.00MM	10	-	3520-4.00X1.5DP	-	-	-	-	-
4.00	0.70	2.0D	8.00MM	10	-	-	-	3520-4.00X2.0DP	-	-	-
5.00	0.80	1.0D	5.00MM	10	3520-5.00X1.0DP	-	-	-	-	-	-
5.00	0.80	1.5D	7.50MM	10	-	3520-5.00X1.5DP	-	-	-	-	-
5.00	0.80	2.0D	10.00MM	10	-	-	-	3520-5.00X2.0DP	-	-	-
6.00	1.00	1.0D	6.00MM	10	3520-6.00X1.0DP	-	-	-	-	-	-
6.00	1.00	1.5D	9.00MM	10	-	3520-6.00X1.5DP	-	-	-	-	-
6.00	1.00	2.0D	12.00MM	10	-	-	-	3520-6.00X2.0DP	-	-	-
7.00	1.00	1.0D	7.00MM	10	3520-7.00X1.0DP	-	-	-	-	-	-
7.00	1.00	1.5D	10.50MM	10	-	3520-7.00X1.5DP	-	-	-	-	-
7.00	1.00	2.0D	14.00MM	10	-	-	-	3520-7.00X2.0DP	-	-	-
8.00	1.25	1.0D	8.00MM	10	3520-8.00X1.0DP	-	-	-	-	-	-
8.00	1.25	1.5D	12.00MM	10	-	3520-8.00X1.5DP	-	-	-	-	-
8.00	1.25	2.0D	16.00MM	10	-	-	-	3520-8.00X2.0DP	-	-	-
9.00	1.25	1.0D	9.00MM	10	3520-9.00X1.0DP	-	-	-	-	-	-
9.00	1.25	1.5D	13.50MM	10	-	3520-9.00X1.5DP	-	-	-	-	-
9.00	1.25	2.0D	18.00MM	10	-	-	-	3520-9.00X2.0DP	-	-	-
10.00	1.50	1.0D	10.00MM	10	3520-10.00X1.0DP	-	-	-	-	-	-
10.00	1.50	1.5D	15.00MM	10	-	3520-10.00X1.5DP	-	-	-	-	-
10.00	1.50	2.0D	20.00MM	10	-	-	-	3520-10.00X2.0DP	-	-	-
11.00	1.50	1.0D	11.00MM	10	3520-11.00X1.0DP	-	-	-	-	-	-
11.00	1.50	1.5D	16.50MM	10	-	3520-11.00X1.5DP	-	-	-	-	-
11.00	1.50	2.0D	22.00MM	10	-	-	-	3520-11.00X2.0DP	-	-	-
12.00	1.75	1.0D	12.00MM	10	3520-12.00X1.0DP	-	-	-	-	-	-
12.00	1.75	1.5D	18.00MM	10	-	3520-12.00X1.5DP	-	-	-	-	-
12.00	1.75	2.0D	24.00MM	10	-	-	-	3520-12.00X2.0DP	-	-	-
13.00	1.75	1.0D	13.00MM	5	3520-13.00X1.0DP	-	-	-	-	-	-
13.00	1.75	1.5D	19.50MM	5	-	3520-13.00X1.5DP	-	-	-	-	-
13.00	1.75	2.0D	26.00MM	5	-	-	-	3520-13.00X2.0DP	-	-	-
14.00	2.00	1.0D	14.00MM	5	3520-14.00X1.0DP	-	-	-	-	-	-
14.00	2.00	1.5D	21.00MM	5	-	3520-14.00X1.5DP	-	-	-	-	-
14.00	2.00	2.0D	28.00MM	5	-	-	-	3520-14.00X2.0DP	-	-	-
15.00	2.00	1.0D	15.00MM	5	3520-15.00X1.0DP	-	-	-	-	-	-
15.00	2.00	1.5D	22.50MM	5	-	3520-15.00X1.5DP	-	-	-	-	-
15.00	2.00	2.0D	30.00MM	5	-	-	-	3520-15.00X2.0DP	-	-	-



MC



Metric Coarse

GROUP	PCRP
INSERT TYPE	WIRE THREAD
INSERT MATERIAL	304 STAINLESS STEEL
STYLE	FREE RUNNING



MC

METRIC COARSE

MM	MM	INSTALLED LENGTH	#	PART #	PART #	PART #
16.00	2.00	1.0D	16.00MM	5	3520-16.00X1.0DP	—
16.00	2.00	1.5D	24.00MM	5	—	3520-16.00X1.5DP
16.00	2.00	2.0D	32.00MM	5	—	3520-16.00X2.0DP
18.00	2.50	1.0D	18.00MM	5	3520-18.00X1.0DP	—
18.00	2.50	1.5D	27.00MM	5	—	3520-18.00X1.5DP
18.00	2.50	2.0D	36.00MM	5	—	3520-18.00X2.0DP
20.00	2.50	1.0D	20.00MM	5	3520-20.00X1.0DP	—
20.00	2.50	1.5D	30.00MM	5	—	3520-20.00X1.5DP
20.00	2.50	2.0D	40.00MM	5	—	3520-20.00X2.0DP
22.00	2.50	1.0D	22.00MM	3	3520-22.00X1.0DP	—
22.00	2.50	1.5D	33.00MM	3	—	3520-22.00X1.5DP
22.00	2.50	2.0D	44.00MM	3	—	3520-22.00X2.0DP
24.00	3.00	1.0D	24.00MM	3	3520-24.00X1.0DP	—
24.00	3.00	1.5D	36.00MM	3	—	3520-24.00X1.5DP
24.00	3.00	2.0D	48.00MM	3	—	3520-24.00X2.0DP

METRIC COARSE

MM	MM	INSTALLED LENGTH	#	PART #	PART #	
3.00	0.50	2.5D	7.50MM	10	3520-3.00X2.5DP	
4.00	0.70	2.5D	10.00MM	10	3520-4.00X2.5DP	
4.00	0.70	3.0D	12.00MM	10	—	3520-4.00X3.0DP
6.00	1.00	2.5D	15.00MM	10	3520-6.00X2.5DP	
6.00	1.00	3.0D	18.00MM	10	—	3520-6.00X3.0DP
7.00	1.00	3.0D	21.00MM	10	—	3520-7.00X3.0DP
8.00	1.25	2.5D	20.00MM	10	3520-8.00X2.5DP	
8.00	1.25	3.0D	24.00MM	10	—	3520-8.00X3.0DP
9.00	1.25	3.0D	27.00MM	10	—	3520-9.00X3.0DP
10.00	1.50	2.5D	25.00MM	10	3520-10.00X2.5DP	
10.00	1.50	3.0D	30.00MM	10	—	3520-10.00X3.0DP
12.00	1.75	2.5D	30.00MM	10	3520-12.00X2.5DP	
12.00	1.75	3.0D	36.00MM	10	—	3520-12.00X3.0DP
14.00	2.00	2.5D	35.00MM	5	3520-14.00X2.5DP	
14.00	2.00	3.0D	42.00MM	5	—	3520-14.00X3.0DP
16.00	2.00	2.5D	40.00MM	5	3520-16.00X2.5DP	
24.00	3.00	2.5D	60.00MM	3	3520-24.00X2.5DP	



GROUP	PCR
INSERT TYPE	WIRE THREAD
INSERT MATERIAL	304 STAINLESS STEEL
STYLE	FREE RUNNING

METRIC FINE							
MM	MM	INSTALLED LENGTH	#	PART #	PART #	PART #	
6.00	0.75	1.0D	6.00	10	3521-6.00X1.0DP	-	-
6.00	0.75	1.5D	9.00	10	-	3521-6.00X1.5DP	-
6.00	0.75	2.0D	12.00	10	-	-	3521-6.00X2.0DP
8.00	1.00	1.0D	8.00	10	3521-8.00X1.0DP	-	-
8.00	1.00	1.5D	12.00	10	-	3521-8.00X1.5DP	-
8.00	1.00	2.0D	16.00	10	-	-	3521-8.00X2.0DP
8.00	0.75	1.0D	8.00	10	3523-8.00X1.0DP	-	-
8.00	0.75	1.5D	12.00	10	-	3523-8.00X1.5DP	-
8.00	0.75	2.0D	16.00	10	-	-	3523-8.00X2.0DP
9.00	1.00	1.0D	9.00	10	3521-9.00X1.0DP	-	-
9.00	1.00	1.5D	13.50	10	-	3521-9.00X1.5DP	-
9.00	1.00	2.0D	18.00	10	-	-	3521-9.00X2.0DP
10.00	1.25	1.0D	10.00	10	3521-10.00X1.0DP	-	-
10.00	1.25	1.5D	15.00	10	-	3521-10.00X1.5DP	-
10.00	1.25	2.0D	20.00	10	-	-	3521-10.00X2.0DP
10.00	1.00	1.0D	10.00	10	3523-10.00X1.0DP	-	-
10.00	1.00	1.5D	15.00	10	-	3523-10.00X1.5DP	-
10.00	1.00	2.0D	20.00	10	-	-	3523-10.00X2.0DP
11.00	1.25	1.0D	11.00	10	3521-11.00X1.0DP	-	-
11.00	1.25	1.5D	16.50	10	-	3521-11.00X1.5DP	-
11.00	1.25	2.0D	22.00	10	-	-	3521-11.00X2.0DP
11.00	1.00	1.0D	11.00	10	3523-11.00X1.0DP	-	-
11.00	1.00	1.5D	16.50	10	-	3523-11.00X1.5DP	-
11.00	1.00	2.0D	22.00	10	-	-	3523-11.00X2.0DP
12.00	1.50	1.0D	12.00	10	3521-12.00X1.0DP	-	-
12.00	1.50	1.5D	18.00	10	-	3521-12.00X1.5DP	-
12.00	1.50	2.0D	24.00	10	-	-	3521-12.00X2.0DP
12.00	1.25	1.0D	12.00	10	3523-12.00X1.0DP	-	-
12.00	1.25	1.5D	18.00	10	-	3523-12.00X1.5DP	-
12.00	1.25	2.0D	24.00	10	-	-	3523-12.00X2.0DP
12.00	1.00	1.0D	12.00	10	3524-12.00X1.0DP	-	-
12.00	1.00	1.5D	18.00	10	-	3524-12.00X1.5DP	-
12.00	1.00	2.0D	24.00	10	-	-	3524-12.00X2.0DP
13.00	1.50	1.0D	13.00	5	3521-13.00X1.0DP	-	-
13.00	1.50	1.5D	19.50	5	-	3521-13.00X1.5DP	-
13.00	1.50	2.0D	26.00	5	-	-	3521-13.00X2.0DP
13.00	1.25	1.0D	13.00	5	3523-13.00X1.0DP	-	-
13.00	1.25	1.5D	19.50	5	-	3523-13.00X1.5DP	-
13.00	1.25	2.0D	26.00	5	-	-	3523-13.00X2.0DP
14.00	1.50	1.0D	14.00	5	3521-14.00X1.0DP	-	-
14.00	1.50	1.5D	21.00	5	-	3521-14.00X1.5DP	-
14.00	1.50	2.0D	28.00	5	-	-	3521-14.00X2.0DP
14.00	1.25	1.0D	14.00	5	3523-14.00X1.0DP	-	-
14.00	1.25	1.5D	21.00	5	-	3523-14.00X1.5DP	-
14.00	1.25	2.0D	28.00	5	-	-	3523-14.00X2.0DP
14.00	1.00	1.0D	14.00	5	3524-14.00X1.0DP	-	-
14.00	1.00	1.5D	21.00	5	-	3524-14.00X1.5DP	-
14.00	1.00	2.0D	28.00	5	-	-	3524-14.00X2.0DP
15.00	1.50	1.0D	15.00	5	3521-15.00X1.0DP	-	-
15.00	1.50	1.5D	22.50	5	-	3521-15.00X1.5DP	-
15.00	1.50	2.0D	30.00	5	-	-	3521-15.00X2.0DP



MF



Metric Fine

GROUP	PCRP
INSERT TYPE	WIRE THREAD
INSERT MATERIAL	304 STAINLESS STEEL
STYLE	FREE RUNNING



MF

METRIC FINE

1.0D		1.5D		2.0D		
MM	MM	INSTALLED LENGTH	#	PART #	PART #	PART #
16.00	1.50	1.0D 16.00MM	5	3521-16.00X1.0DP	-	-
16.00	1.50	1.5D 24.00MM	5	-	3521-16.00X1.5DP	-
16.00	1.50	2.0D 32.00MM	5	-	-	3521-16.00X2.0DP
18.00	2.00	1.0D 18.00MM	5	3521-18.00X1.0DP	-	-
18.00	2.00	1.5D 27.00MM	5	-	3521-18.00X1.5DP	-
18.00	2.00	2.0D 36.00MM	5	-	-	3521-18.00X2.0DP
18.00	1.50	1.0D 18.00MM	5	3523-18.00X1.0DP	-	-
18.00	1.50	1.5D 27.00MM	5	-	3523-18.00X1.5DP	-
18.00	1.50	2.0D 36.00MM	5	-	-	3523-18.00X2.0DP
20.00	2.00	1.0D 20.00MM	5	3521-20.00X1.0DP	-	-
20.00	2.00	1.5D 30.00MM	5	-	3521-20.00X1.5DP	-
20.00	2.00	2.0D 40.00MM	5	-	-	3521-20.00X2.0DP
20.00	1.50	1.0D 20.00MM	5	3523-20.00X1.0DP	-	-
20.00	1.50	1.5D 30.00MM	5	-	3523-20.00X1.5DP	-
20.00	1.50	2.0D 40.00MM	5	-	-	3523-20.00X2.0DP
20.00	1.25	1.5D 30.00MM	5	-	3524-20.00X1.5DP	-
22.00	2.00	1.0D 22.00MM	3	3521-22.00X1.0DP	-	-
22.00	2.00	1.5D 33.00MM	3	-	3521-22.00X1.5DP	-
22.00	2.00	2.0D 44.00MM	3	-	-	3521-22.00X2.0DP
22.00	1.50	1.0D 22.00MM	3	3523-22.00X1.0DP	-	-
22.00	1.50	1.5D 33.00MM	3	-	3523-22.00X1.5DP	-
22.00	1.50	2.0D 44.00MM	3	-	-	3523-22.00X2.0DP
24.00	2.00	1.0D 24.00MM	3	3521-24.00X1.0DP	-	-
24.00	2.00	1.5D 36.00MM	3	-	3521-24.00X1.5DP	-
24.00	2.00	2.0D 48.00MM	3	-	-	3521-24.00X2.0DP
24.00	1.50	1.0D 24.00MM	3	3523-24.00X1.0DP	-	-
24.00	1.50	1.5D 36.00MM	3	-	3523-24.00X1.5DP	-
24.00	1.50	2.0D 48.00MM	3	-	-	3523-24.00X2.0DP



GROUP	PCRP
INSERT TYPE	WIRE THREAD
INSERT MATERIAL	304 STAINLESS STEEL
STYLE	FREE RUNNING

SPARK PLUG							
MM	MM	LENGTH	#	PART #	PART #	PART #	PART #
10.00	1.00	0.339"	10	3522-10.00X.339P	-	-	-
10.00	1.00	1/2"	10	-	3522-10.00X1/2P	-	-
12.00	1.25	1/2"	10	-	3522-12.00X1/2P	-	-
12.00	1.25	3/4"	10	-	-	-	3522-12.00X3/4P
18.00	1.25	1/2"	10	-	3522-18.00X1/2P	-	-

SPARK PLUG							
MM	MM	LENGTH	#	PART #	PART #	PART #	PART #
14.00	1.25	3/8"	10	3522-14.00X3/8P	-	-	-
14.00	1.25	7/16"	10	-	3522-14.00X7/16P	-	-
14.00	1.25	1/2"	10	-	-	3522-14.00X1/2P	-
14.00	1.25	3/4"	10	-	-	-	3522-14.00X3/4P

SPARK PLUG							
MM	MM	LENGTH	#	PART #	PART #	PART #	PART #
14	1.25	8.4MM	10	3522-14.00X8.4P	-	-	-
14	1.25	12.4MM	10	-	3522-14.00X12.4P	-	-
14	1.25	16.4MM	10	-	-	-	3522-14.00X16.4P





UNC

GROUP	PCRP
INSERT TYPE	WIRE THREAD
INSERT MATERIAL	304 STAINLESS STEEL
STYLE	FREE RUNNING



UNC

INCH	TPI	INSTALLED LENGTH		#	PART #		
		1.0D	1.5D		2.0D	1.0D	1.5D
2G	56	1.0D	0.09"	10	3532-2GX1.0DP	-	-
2G	56	1.5D	0.13"	10	-	3532-2GX1.5DP	-
2G	56	2.0D	0.17"	10	-	-	3532-2GX2.0DP
3G	48	1.0D	0.10"	10	3532-3GX1.0DP	-	-
3G	48	1.5D	0.15"	10	-	3532-3GX1.5DP	-
3G	48	2.0D	0.20"	10	-	-	3532-3GX2.0DP
4G	40	1.0D	0.11"	10	3532-4GX1.0DP	-	-
4G	40	1.5D	0.17"	10	-	3532-4GX1.5DP	-
4G	40	2.0D	0.22"	10	-	-	3532-4GX2.0DP
5G	40	1.0D	0.13"	10	3532-5GX1.0DP	-	-
5G	40	1.5D	0.19"	10	-	3532-5GX1.5DP	-
5G	40	2.0D	0.25"	10	-	-	3532-5GX2.0DP
6G	32	1.0D	0.14"	10	3532-6GX1.0DP	-	-
6G	32	1.5D	0.21"	10	-	3532-6GX1.5DP	-
6G	32	2.0D	0.28"	10	-	-	3532-6GX2.0DP
8G	32	1.0D	0.16"	10	3532-8GX1.0DP	-	-
8G	32	1.5D	0.25"	10	-	3532-8GX1.5DP	-
8G	32	2.0D	0.33"	10	-	-	3532-8GX2.0DP
10G	24	1.0D	0.19"	10	3532-10GX1.0DP	-	-
10G	24	1.5D	0.29"	10	-	3532-10GX1.5DP	-
10G	24	2.0D	0.38"	10	-	-	3532-10GX2.0DP
12G	24	1.0D	0.22"	10	3532-12GX1.0DP	-	-
12G	24	1.5D	0.32"	10	-	3532-12GX1.5DP	-
12G	24	2.0D	0.43"	10	-	-	3532-12GX2.0DP
1/4	20	1.0D	0.25"	10	3532-1/4X1.0DP	-	-
1/4	20	1.5D	0.38"	10	-	3532-1/4X1.5DP	-
1/4	20	2.0D	0.50"	10	-	-	3532-1/4X2.0DP
5/16	18	1.0D	0.31"	10	3532-5/16X1.0DP	-	-
5/16	18	1.5D	0.47"	10	-	3532-5/16X1.5DP	-
5/16	18	2.0D	0.63"	10	-	-	3532-5/16X2.0DP
3/8	16	1.0D	0.38"	10	3532-3/8X1.0DP	-	-
3/8	16	1.5D	0.56"	10	-	3532-3/8X1.5DP	-
3/8	16	2.0D	0.75"	10	-	-	3532-3/8X2.0DP
7/16	14	1.0D	0.44"	10	3532-7/16X1.0DP	-	-
7/16	14	1.5D	0.66"	10	-	3532-7/16X1.5DP	-
7/16	14	2.0D	0.88"	10	-	-	3532-7/16X2.0DP
1/2	13	1.0D	0.50"	10	3532-1/2X1.0DP	-	-
1/2	13	1.5D	0.75"	10	-	3532-1/2X1.5DP	-
1/2	13	2.0D	1.00"	10	-	-	3532-1/2X2.0DP
9/16	12	1.0D	0.56"	5	3532-9/16X1.0DP	-	-
9/16	12	1.5D	0.84"	5	-	3532-9/16X1.5DP	-
9/16	12	2.0D	1.13"	5	-	-	3532-9/16X2.0DP
5/8	11	1.0D	0.63"	5	3532-5/8X1.0DP	-	-
5/8	11	1.5D	0.94"	5	-	3532-5/8X1.5DP	-
5/8	11	2.0D	1.25"	5	-	-	3532-5/8X2.0DP
3/4	10	1.0D	0.75"	5	3532-3/4X1.0DP	-	-
3/4	10	1.5D	1.13"	5	-	3532-3/4X1.5DP	-
3/4	10	2.0D	1.50"	5	-	-	3532-3/4X2.0DP
7/8	9	1.0D	0.88"	3	3532-7/8X1.0DP	-	-
7/8	9	1.5D	1.31"	3	-	3532-7/8X1.5DP	-
7/8	9	2.0D	1.75"	3	-	-	3532-7/8X2.0DP
1	8	1.0D	1.00"	3	3532-1X1.0DP	-	-
1	8	1.5D	1.50"	3	-	3532-1X1.5DP	-
1	8	2.0D	2.00"	3	-	-	3532-1X2.0DP



UNC



GROUP	PCRP
INSERT TYPE	WIRE THREAD
INSERT MATERIAL	304 STAINLESS STEEL
STYLE	FREE RUNNING

UNF				1.0D			1.5D			2.0D		
INCH	TPI	INSTALLED LENGTH	#	PART #	PART #	PART #	PART #	PART #	PART #	PART #	PART #	
3G	56	1.0D	0.10"	10	3534-3GX1.0DP	-	-	-	-	-	-	
3G	56	1.5D	0.15"	10	-	3534-3GX1.5DP	-	-	-	-	-	
3G	56	2.0D	0.20"	10	-	-	-	3534-3GX2.0DP	-	-	-	
4G	48	1.0D	0.11"	10	3534-4GX1.0DP	-	-	-	-	-	-	
4G	48	1.5D	0.17"	10	-	3534-4GX1.5DP	-	-	-	-	-	
4G	48	2.0D	0.22"	10	-	-	-	3534-4GX2.0DP	-	-	-	
6G	40	1.0D	0.14"	10	3534-6GX1.0DP	-	-	-	-	-	-	
6G	40	1.5D	0.21"	10	-	3534-6GX1.5DP	-	-	-	-	-	
6G	40	2.0D	0.28"	10	-	-	-	3534-6GX2.0DP	-	-	-	
8G	36	1.0D	0.16"	10	3534-8GX1.0DP	-	-	-	-	-	-	
8G	36	1.5D	0.25"	10	-	3534-8GX1.5DP	-	-	-	-	-	
8G	36	2.0D	0.33"	10	-	-	-	3534-8GX2.0DP	-	-	-	
10G	32	1.0D	0.19"	10	3534-10GX1.0DP	-	-	-	-	-	-	
10G	32	1.5D	0.29"	10	-	3534-10GX1.5DP	-	-	-	-	-	
10G	32	2.0D	0.38"	10	-	-	-	3534-10GX2.0DP	-	-	-	
12G	28	1.0D	0.22"	10	3534-12GX1.0DP	-	-	-	-	-	-	
12G	28	1.5D	0.32"	10	-	3534-12GX1.5DP	-	-	-	-	-	
12G	28	2.0D	0.43"	10	-	-	-	3534-12GX2.0DP	-	-	-	
1/4	32	1.5D	0.38"	10	-	3535-1/4X1.5DP	-	-	-	-	-	
1/4	28	1.0D	0.25"	10	3534-1/4X1.0DP	-	-	-	-	-	-	
1/4	28	1.5D	0.38"	10	-	3534-1/4X1.5DP	-	-	-	-	-	
1/4	28	2.0D	0.50"	10	-	-	-	3534-1/4X2.0DP	-	-	-	
1/4	24	1.0D	0.25"	10	3534-1/4X1.0DP	-	-	-	-	-	-	
1/4	24	1.5D	0.38"	10	-	3534-1/4X1.5DP	-	-	-	-	-	
1/4	24	2.0D	0.50"	10	-	-	-	3534-1/4X2.0DP	-	-	-	
5/16	24	1.0D	0.31"	10	3534-5/16X1.0DP	-	-	-	-	-	-	
5/16	24	1.5D	0.47"	10	-	3534-5/16X1.5DP	-	-	-	-	-	
5/16	24	2.0D	0.62"	10	-	-	-	3534-5/16X2.0DP	-	-	-	
3/8	24	1.0D	0.38"	10	3534-3/8X1.0DP	-	-	-	-	-	-	
3/8	24	1.5D	0.57"	10	-	3534-3/8X1.5DP	-	-	-	-	-	
3/8	24	2.0D	0.76"	10	-	-	-	3534-3/8X2.0DP	-	-	-	
7/16	20	1.0D	0.44"	10	3534-7/16X1.0DP	-	-	-	-	-	-	
7/16	20	1.5D	0.66"	10	-	3534-7/16X1.5DP	-	-	-	-	-	
7/16	20	2.0D	0.88"	10	-	-	-	3534-7/16X2.0DP	-	-	-	
7/16	16	1.5D	0.66"	10	-	3534-7/16X1.5DP	-	-	-	-	-	
1/2	20	1.0D	0.50"	10	3534-1/2X1.0DP	-	-	-	-	-	-	
1/2	20	1.5D	0.75"	10	-	3534-1/2X1.5DP	-	-	-	-	-	
1/2	20	2.0D	1.00"	10	-	-	-	3534-1/2X2.0DP	-	-	-	
9/16	18	1.0D	0.56"	5	3534-9/16X1.0DP	-	-	-	-	-	-	
9/16	18	1.5D	0.84"	5	-	3534-9/16X1.5DP	-	-	-	-	-	
9/16	18	2.0D	1.12"	5	-	-	-	3534-9/16X2.0DP	-	-	-	
5/8	18	1.0D	0.63"	5	3534-5/8X1.0DP	-	-	-	-	-	-	
5/8	18	1.5D	0.95"	5	-	3534-5/8X1.5DP	-	-	-	-	-	
5/8	18	2.0D	1.26"	5	-	-	-	3534-5/8X2.0DP	-	-	-	
3/4	16	1.0D	0.75"	5	3534-3/4X1.0DP	-	-	-	-	-	-	
3/4	16	1.5D	1.13"	5	-	3534-3/4X1.5DP	-	-	-	-	-	
3/4	16	2.0D	1.50"	5	-	-	-	3534-3/4X2.0DP	-	-	-	
7/8	14	1.0D	0.88"	3	3534-7/8X1.0DP	-	-	-	-	-	-	
7/8	14	1.5D	1.32"	3	-	3534-7/8X1.5DP	-	-	-	-	-	
7/8	14	2.0D	1.76"	3	-	-	-	3534-7/8X2.0DP	-	-	-	
1	14	1.0D	1.00"	3	3535-1X1.0DP	-	-	-	-	-	-	
1	14	1.5D	1.50"	3	-	3535-1X1.5DP	-	-	-	-	-	
1	14	2.0D	2.00"	3	-	-	-	3535-1X2.0DP	-	-	-	
1	12	1.0D	1.00"	3	3534-1X1.0DP	-	-	-	-	-	-	
1	12	1.5D	1.50"	3	-	3534-1X1.5DP	-	-	-	-	-	
1	12	2.0D	2.00"	3	-	-	-	3534-1X2.0DP	-	-	-	



UNF



GROUP	PCRK
INSERT TYPE	WIRE THREAD
INSERT MATERIAL	304 STAINLESS STEEL
STYLE	FREE RUNNING

MERCHANDISER	PART #
POWER COIL HANG SELL MERCHANDISER	3500-D1

CONTENTS			
#	MM / INCH	PART #	PART #
	METRIC COARSE		
1	4 x 0.7	3520-4.00K	3520-4.00 x 1.5DP
1	5 x 0.8	3520-5.00K	3520-5.00 x 1.5DP
1	6 x 1.0	3520-6.00K	3520-6.00 x 1.5DP
1	6 x 1.0	—	3520-6.00 x 2.0DP
1	8 x 1.25	3520-8.00K	3520-8.00 x 1.5DP
1	8 x 1.25	—	3520-8.00 x 2.0DP
1	10 x 1.5	3520-10.00K	3520-10.00 x 1.5DP
1	12 x 1.75	3520-12.00K	3520-12.00 x 1.5DP
1	12 x 1.75	—	3520-12.00 x 2.0DP
1	16 x 2.0	3520-16.00K	3520-16.00 x 1.5DP
1	10 x 1.25	3521-10.00K	3521-10.00 x 1.5DP
1	12 x 1.5	3521-12.00K	3521-12.00 x 1.5DP
	SPARK PLUG		
1	12 x 1.25	3522-12.00K	3522-12.00 x 1/2P
1	12 x 1.25	—	3522-12.00 x 3/4P
1	14 x 1.25	3522-14.00K	3522-14.00 x 3/8P
1	14 x 1.25	—	3522-14.00 x 1/2P
1	14 x 1.25	—	3522-14.00 x 3/4P
	UNC		
1	1/4 x 20	3532-1/4K	3532-1/4 x 1.5DP
1	5/16 x 18	3532-5/16K	3532-5/16 x 1.5DP
1	3/8 x 16	3532-3/8K	3532-3/8 x 1.5DP
1	3/8 x 16	—	3532-3/8 x 2.0DP
1	7/16 x 14	3532-7/16K	3532-7/16 x 1.5DP
1	1/2 x 13	3532-1/2K	3532-1/2 x 1.5DP
1	5/8 x 11	3532-5/8K	3532-5/8 x 1.5DP
1	3/4 x 10	3532-3/4K	3532-3/4 x 1.5DP
	UNF		
1	1/4 x 28	3534-1/4K	3534-1/4 x 1.5DP
1	5/16 x 24	3534-5/16K	3534-5/16 x 1.5DP
1	3/8 x 24	3534-3/8K	3534-3/8 x 1.5DP
1	7/16 x 20	3534-7/16K	3534-7/16 x 1.5DP
1	1/2 x 20	3534-1/2K	3534-1/2 x 1.5DP
	BSW		
1	1/2 x 12	3528-1/2K	3528-1/2 x 1.5DP

 Picture is representative of merchandiser appearance. Actual contents as listed.





PowerCoil bench merchandisers are double sided units that display thread repair kits on one side and replacement insert packets on the other.

GROUP	PCRK
INSERT TYPE	WIRE THREAD
INSERT MATERIAL	304 STAINLESS STEEL
STYLE	FREE RUNNING

MERCHANDISER	PART #
POWERCOIL BENCH MERCHANDISER	3500-CS1

CONTENTS			
#	MM / INCH	PART #	PART #
	METRIC COARSE		
1	5 x 0.8	3520-5.00K	3520-5.00 x 1.5DP
1	6 x 1.0	3520-6.00K	3520-6.00 x 1.0DP
1	6 x 1.0	-	3520-6.00 x 1.5DP
1	6 x 1.0	-	3520-6.00 x 2.0DP
1	8 x 1.25	3520-8.00K	3520-8.00 x 1.0DP
1	8 x 1.25	-	3520-8.00 x 1.5DP
1	8 x 1.25	-	3520-8.00 x 2.0DP
1	10 x 1.5	3520-10.00K	3520-10.00 x 1.5DP
1	10 x 1.5	-	3520-10.00 x 2.0DP
1	12 x 1.75	3520-12.00K	3520-12.00 x 1.5DP
1	16 x 2.0	3520-16.00K	3520-16.00 x 1.5DP
	SPARK PLUG		
1	14 x 1.25	3522-14.00K	3522-14.00 x 3/8P
1	14 x 1.25	-	3522-14.00 x 1/2P
1	14 x 1.25	-	3522-14.00 x 3/4P

MERCHANDISER	PART #
POWERCOIL HANG SELL MERCHANDISER	3500-CS2

CONTENTS			
#	MM / INCH	PART #	PART #
	METRIC COARSE		
1	6 x 1.0	3520-6.00K	3520-6.00 x 1.0DP
1	6 x 1.0	-	3520-6.00 x 1.5DP
1	6 x 1.0	-	3520-6.00 x 2.0DP
1	8 x 1.25	3520-8.00K	3520-8.00 x 1.0DP
1	8 x 1.25	-	3520-8.00 x 1.5DP
1	8 x 1.25	-	3520-8.00 x 2.0DP
1	10 x 1.5	3520-10.00K	3520-10.00 x 1.5DP
1	12 x 1.75	3520-12.00K	3520-12.00 x 1.5DP
	UNC		
1	1/4 x 20	3532-1/4K	3532-1/4 x 1.5DP
1	5/16 x 18	3532-5/16K	3532-5/16 x 1.5DP
1	3/8 x 16	3532-3/8K	3532-3/8 x 1.5DP
1	3/8 x 16	-	3532-3/8 x 2.0DP
1	1/2 x 13	3532-1/2K	3532-1/2 x 1.5DP



MC





Metric Course

GROUP	PCWI
INSERT TYPE	WIRE THREAD
INSERT MATERIAL	304 STAINLESS STEEL
STYLE	FREE RUNNING



MC

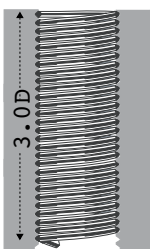
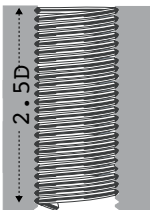
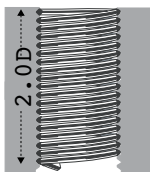
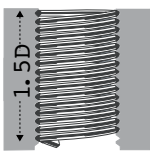

METRIC COARSE		1.0D BULK INSERTS		1.5D BULK INSERTS		2.0D BULK INSERTS		2.5D BULK INSERTS		3.0D BULK INSERTS	
MM	MM	MM	PART #	MM	PART #	MM	PART #	MM	PART #	MM	PART #
2.00	0.40	2.00	3520-2.00X1.0D	3.00	3520-2.00X1.5D	4.00	3520-2.00X2.0D	5.00	3520-2.00X2.5D	6.00	3520-2.00X3.0D
2.20	0.45	2.20	3520-2.20X1.0D	3.30	3520-2.00X1.5D	4.40	3520-2.20X2.0D	5.50	3520-2.20X2.5D	6.60	3520-2.20X3.0D
2.50	0.45	2.50	3520-2.50X1.0D	3.75	3520-2.50X1.5D	5.00	3520-2.50X2.0D	6.25	3520-2.50X2.5D	7.50	3520-2.50X3.0D
3.00	0.50	3.00	3520-3.00X1.0D	4.50	3520-3.00X1.5D	6.00	3520-3.00X2.0D	7.50	3520-3.00X2.5D	9.00	3520-3.00X3.0D
3.50	0.60	3.50	3520-3.50X1.0D	5.25	3520-3.50X1.5D	7.00	3520-3.50X2.0D	8.75	3520-3.50X2.5D	10.50	3520-3.50X3.0D
4.00	0.70	4.00	3520-4.00X1.0D	6.00	3520-4.00X1.5D	8.00	3520-4.00X2.0D	10.00	3520-4.00X2.5D	12.00	3520-4.00X3.0D
5.00	0.80	5.00	3520-5.00X1.0D	7.50	3520-5.00X1.5D	10.00	3520-5.00X2.0D	12.50	3520-5.00X2.5D	15.00	3520-5.00X3.0D
6.00	1.00	6.00	3520-6.00X1.0D	9.00	3520-6.00X1.5D	12.00	3520-6.00X2.0D	15.00	3520-6.00X2.5D	18.00	3520-6.00X3.0D
7.00	1.00	7.00	3520-7.00X1.0D	10.50	3520-7.00X1.5D	14.00	3520-7.00X2.0D	17.50	3520-7.00X2.5D	21.00	3520-7.00X3.0D
8.00	1.25	8.00	3520-8.00X1.0D	12.00	3520-7.00X1.5D	16.00	3520-8.00X2.0D	20.00	3520-8.00X2.5D	24.00	3520-8.00X3.0D
9.00	1.25	9.00	3520-9.00X1.0D	13.50	3520-9.00X1.5D	18.00	3520-9.00X2.0D	22.50	3520-9.00X2.5D	27.00	3520-9.00X3.0D
10.00	1.50	10.00	3520-10.00X1.0D	15.00	3520-10.00X1.5D	20.00	3520-10.00X2.0D	25.00	3520-10.00X2.5D	30.00	3520-10.00X3.0D
11.00	1.50	11.00	3520-11.00X1.0D	16.50	3520-11.00X1.5D	22.00	3520-11.00X2.0D	27.50	3520-11.00X2.5D	33.00	3520-11.00X3.0D
12.00	1.75	12.00	3520-12.00X1.0D	18.00	3520-12.00X1.5D	24.00	3520-12.00X2.0D	30.00	3520-12.00X2.5D	36.00	3520-12.00X3.0D
13.00	1.75	13.00	3520-13.00X1.0D	19.50	3520-13.00X1.5D	26.00	3520-13.00X2.0D				
14.00	2.00	14.00	3520-14.00X1.0D	21.00	3520-14.00X1.5D	28.00	3520-14.00X2.0D	35.00	3520-14.00X2.5D	42.00	3520-14.00X3.0D
15.00	2.00	15.00	3520-15.00X1.0D	22.50	3520-15.00X1.5D	30.00	3520-15.00X2.0D				
16.00	2.00	16.00	3520-16.00X1.0D	24.00	3520-16.00X1.5D	32.00	3520-16.00X2.0D	40.00	3520-16.00X2.5D	48.00	3520-16.00X3.0D
18.00	2.50	18.00	3520-18.00X1.0D	27.00	3520-18.00X1.5D	36.00	3520-18.00X2.0D	45.00	3520-18.00X2.5D	54.00	3520-18.00X3.0D
20.00	2.50	20.00	3520-20.00X1.0D	30.00	3520-20.00X1.5D	40.00	3520-20.00X2.0D	50.00	3520-20.00X2.5D	60.00	3520-20.00X3.0D
22.00	2.50	22.00	3520-22.00X1.0D	33.00	3520-22.00X1.5D	44.00	3520-22.00X2.0D	55.00	3520-22.00X2.5D	66.00	3520-22.00X3.0D
24.00	3.00	24.00	3520-24.00X1.0D	36.00	3520-24.00X1.5D	48.00	3520-24.00X2.0D	60.00	3520-24.00X2.5D	72.00	3520-24.00X3.0D
27.00	3.00			40.50	3520-27.00X1.5D						
30.00	3.50			45.00	3520-30.00X1.5D						
33.00	3.50			49.50	3520-33.00X1.5D						
36.00	4.00			54.00	3520-36.00X1.5D						

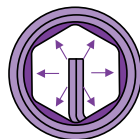

Screw Locking Wire Thread Inserts

Screw locking (or prevailing torque) inserts are of particular value in applications subject to the effects of cyclic vibration or impact. In addition to the benefits afforded by free running inserts, PowerCoil screw locking inserts offer the additional security of prevailing locking torque. This is achieved by the action of one or more polygonal grip coils positioned within the insert's length, which exert radial pressure on the male thread. Each grip coil consists of a number of tangential locking chords which protrude inside the minor diameter of the normal free running coils. As the male thread passes through these grip coils, the locking flats are displaced thus exerting radial pressure or prevailing torque on the male thread. On removal of the male thread, the locking coils relax to their original form permitting repeated assembly while retaining a measurable level of prevailing torque.

Note: It is recommended that only close fit plated or lubricated bolts or screws are used with screw locking inserts.

Call for the latest pricing and availability.



GROUP	PCWI
INSERT TYPE	WIRE THREAD
INSERT MATERIAL	304 STAINLESS STEEL
STYLE	FREE RUNNING



MF

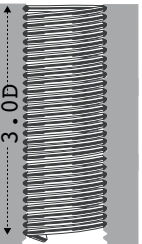
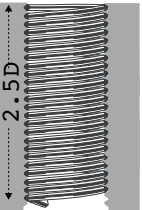
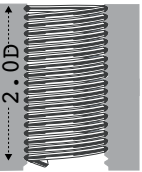
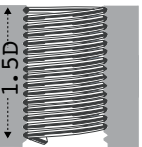

METRIC FINE		1.0D BULK INSERT		1.5D BULK INSERTS		2.0D BULK INSERTS		2.5D BULK INSERTS		3.0D BULK INSERTS	
MM	MM	MM	PART #	MM	PART #	MM	PART #	MM	PART #	MM	PART #
6.00	0.75	6.00	3521-6.00X1.0D	9.00	3521-6.00X1.5D	12.00	3521-6.00X2.0D	15.00	3521-6.00X2.5D	18.00	3521-6.00X3.0D
8.00	1.00	8.00	3521-8.00X1.0D	12.00	3521-8.00X1.5D	16.00	3521-8.00X2.0D	20.00	3521-8.00X2.5D	24.00	3521-8.00X3.0D
8.00	0.75	8.00	3523-8.00X1.0D	12.00	3523-8.00X1.5D	16.00	3523-8.00X2.0D	20.00	3523-8.00X2.5D	24.00	3523-8.00X3.0D
9.00	1.00	9.00	3521-9.00X1.0D	13.50	3521-9.00X1.5D	18.00	3521-9.00X2.0D	22.50	3521-9.00X2.5D	27.00	3521-9.00X3.0D
10.00	1.25	10.00	3521-10.00X1.0D	15.00	3521-10.00X1.5D	20.00	3521-10.00X2.0D	25.00	3521-10.00X2.5D	30.00	3521-10.00X3.0D
10.00	1.00	10.00	3523-10.00X1.0D	15.00	3523-10.00X1.5D	20.00	3523-10.00X2.0D	25.00	3523-10.00X2.5D	30.00	3523-10.00X3.0D
11.00	1.25	11.00	3521-11.00X1.0D	16.50	3521-11.00X1.5D	22.00	3521-11.00X2.0D	27.50	3521-11.00X2.5D	33.00	3521-11.00X3.0D
11.00	1.00	11.00	3523-11.00X1.0D	16.50	3523-11.00X1.5D	22.00	3523-11.00X2.0D	27.50	3523-11.00X2.5D	33.00	3523-11.00X3.0D
12.00	1.50	12.00	3521-12.00X1.0D	18.00	3521-12.00X1.5D	24.00	3521-12.00X2.0D	30.00	3521-12.00X2.5D	36.00	3521-12.00X3.0D
12.00	1.25	12.00	3523-12.00X1.0D	18.00	3523-12.00X1.5D	24.00	3523-12.00X2.0D	30.00	3523-12.00X2.5D	36.00	3523-12.00X3.0D
12.00	1.00	12.00	3524-12.00X1.0D	18.00	3524-12.00X1.5D	24.00	3524-12.00X2.0D	30.00	3524-12.00X2.5D	36.00	3524-12.00X3.0D
13.00	1.50	13.00	3521-13.00X1.0D	19.50	3521-13.00X1.5D	26.00	3521-13.00X2.0D				
13.00	1.25	13.00	3523-13.00X1.0D	19.50	3523-13.00X1.5D	26.00	3523-13.00X2.0D				
14.00	1.50	14.00	3521-14.00X1.0D	21.00	3521-14.00X1.5D	28.00	3521-14.00X2.0D	35.00	3521-14.00X2.5D	42.00	3521-14.00X3.0D
14.00	1.25	14.00	3523-14.00X1.0D	21.00	3523-14.00X1.5D	28.00	3523-14.00X2.0D	35.00	3523-14.00X2.5D	42.00	3523-14.00X3.0D
14.00	1.00	14.00	3524-14.00X1.0D	21.00	3524-14.00X1.5D	28.00	3524-14.00X2.0D	35.00	3524-14.00X2.5D	42.00	3524-14.00X3.0D
15.00	1.50	15.00	3521-15.00X1.0D	22.50	3521-15.00X1.5D	30.00	3521-15.00X2.0D				
16.00	1.50	16.00	3521-16.00X1.0D	24.00	3521-16.00X1.5D	32.00	3521-16.00X2.0D	40.00	3521-16.00X2.5D	48.00	3521-16.00X3.0D
18.00	2.00	18.00	3521-18.00X1.0D	27.00	3521-18.00X1.5D	36.00	3521-18.00X2.0D	45.00	3521-18.00X2.5D	54.00	3521-18.00X3.0D
18.00	1.50	18.00	3523-18.00X1.0D	27.00	3523-18.00X1.5D	36.00	3523-18.00X2.0D	45.00	3523-18.00X2.5D	54.00	3523-18.00X3.0D
20.00	2.00	20.00	3521-20.00X1.0D	30.00	3521-20.00X1.5D	40.00	3521-20.00X2.0D	50.00	3521-20.00X2.5D	60.00	3521-20.00X3.0D
20.00	1.50	20.00	3523-20.00X1.0D	30.00	3523-20.00X1.5D	40.00	3523-20.00X2.0D	50.00	3523-20.00X2.5D	60.00	3523-20.00X3.0D
22.00	2.00	22.00	3521-22.00X1.0D	33.00	3521-22.00X1.5D	44.00	3521-22.00X2.0D	55.00	3521-22.00X2.5D	66.00	3521-22.00X3.0D
22.00	1.50	22.00	3523-22.00X1.0D	33.00	3523-22.00X1.5D	44.00	3523-22.00X2.0D	55.00	3523-22.00X2.5D	66.00	3523-22.00X3.0D
24.00	2.00	24.00	3521-24.00X1.0D	36.00	3521-24.00X1.5D	48.00	3521-24.00X2.0D	60.00	3521-24.00X2.5D	72.00	3521-24.00X3.0D
24.00	1.50	24.00	3523-24.00X1.0D	36.00	3523-24.00X1.5D	48.00	3523-24.00X2.0D	60.00	3523-24.00X2.5D	72.00	3523-24.00X3.0D
26.00	1.50	39.00		39.00	3523-26.00X1.5D						
27.00	2.00	40.50		40.50	3521-27.00X1.5D						
27.00	1.50	40.50		40.50	3523-27.00X1.5D						
28.00	1.50	42.00		42.00	3523-28.00X1.5D						
30.00	2.00	45.00		45.00	3521-30.00X1.5D						
30.00	1.50	45.00		45.00	3523-30.00X1.5D						
33.00	2.00	49.50		49.50	3521-33.00X1.5D						
36.00	3.00	54.00		54.00	3521-36.00X1.5D						
36.00	2.00	54.00		54.00	3523-36.00X1.5D						
36.00	1.50	54.00		54.00	3524-36.00X1.5D						



Strip Feed
Free Running Inserts
Page 27



UNC

GROUP	PCWI
INSERT TYPE	WIRE THREAD
INSERT MATERIAL	304 STAINLESS STEEL
STYLE	FREE RUNNING



UNC		1.0D BULK INSERT		1.5D BULK INSERTS		2.0D BULK INSERTS		2.5D BULK INSERTS		3.0D BULK INSERTS	
INCH	TPI	INCH	PART #	INCH	PART #	INCH	PART #	INCH	PART #	INCH	PART #
2G	56	0.09	3532-2GX1.0D	0.14	3532-2GX1.5D	0.18	3532-2GX2.0D	0.23	3532-2GX2.5D	0.27	3532-2GX3.0D
3G	48	0.10	3532-3GX1.0D	0.15	3532-3GX1.5D	0.20	3532-3GX2.0D				
4G	40	0.11	3532-4GX1.0D	0.17	3532-4GX1.5D	0.22	3532-4GX2.0D	0.25	3532-4GX2.5D	0.33	3532-4GX3.0D
5G	40	0.13	3532-5GX1.0D	0.20	3532-5GX1.5D	0.26	3532-5GX2.0D	0.28	3532-5GX2.5D	0.39	3532-5GX3.0D
6G	32	0.14	3532-6GX1.0D	0.21	3532-6GX1.5D	0.28	3532-6GX2.0D	0.33	3532-6GX2.5D	0.42	3532-6GX3.0D
8G	32	0.16	3532-8GX1.0D	0.24	3532-8GX1.5D	0.32	3532-8GX2.0D	0.35	3532-8GX2.5D	0.48	3532-8GX3.0D
10G	24	0.19	3532-10GX1.0D	0.29	3532-10GX1.5D	0.38	3532-10GX2.0D	0.40	3532-10GX2.5D	0.57	3532-10GX3.0D
12G	24	0.22	3532-12GX1.0D	0.33	3532-12GX1.5D	0.44	3532-12GX2.0D	0.48	3532-12GX2.5D	0.66	3532-12GX3.0D
1/4	20	0.25	3532-1/4X1.0D	0.38	3532-1/4X1.5D	0.50	3532-1/4X2.0D	0.55	3532-1/4X2.5D	0.75	3532-1/4X3.0D
5/16	18	0.31	3532-5/16X1.0D	0.47	3532-5/16X1.5D	0.62	3532-5/16X2.0D	0.63	3532-5/16X2.5D	0.93	3532-5/16X3.0D
3/8	16	0.38	3532-3/8X1.0D	0.57	3532-3/8X1.5D	0.76	3532-3/8X2.0D	0.78	3532-3/8X2.5D	1.14	3532-3/8X3.0D
7/16	14	0.44	3532-7/16X1.0D	0.66	3532-7/16X1.5D	0.88	3532-7/16X2.0D	0.95	3532-7/16X2.5D	1.32	3532-7/16X3.0D
1/2	13	0.50	3532-1/2X1.0D	0.75	3532-1/2X1.5D	1.00	3532-1/2X2.0D	1.10	3532-1/2X2.5D	1.50	3532-1/2X3.0D
9/16	12	0.56	3532-9/16X1.0D	0.84	3532-9/16X1.5D	1.12	3532-9/16X2.0D	1.25	3532-9/16X2.5D	1.68	3532-9/16X3.0D
5/8	11	0.63	3532-5/8X1.0D	0.95	3532-5/8X1.5D	1.26	3532-5/8X2.0D	1.40	3532-5/8X2.5D	1.89	3532-5/8X3.0D
3/4	10	0.75	3532-3/4X1.0D	1.13	3532-3/4X1.5D	1.50	3532-3/4X2.0D	1.58	3532-3/4X2.5D	2.25	3532-3/4X3.0D
7/8	9	0.88	3532-7/8X1.0D	1.32	3532-7/8X1.5D	1.76	3532-7/8X2.0D	1.88	3532-7/8X2.5D	2.64	3532-7/8X3.0D
1	8	1.00	3532-1X1.0D	1.50	3532-1X1.5D	2.00	3532-1X2.0D	2.50	3532-1X2.5D	3.00	3532-1X3.0D
1-1/8	7			1.70	3532-1.1/8X1.5D						
1-1/4	7			1.88	3532-1.1/4X1.5D						
1-3/8	6			2.07	3532-1.3/8X1.5D						
1-1/2	6			2.25	3532-1.1/2X1.5D						



UNC

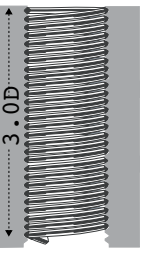
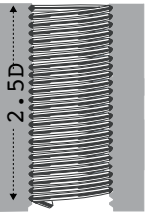
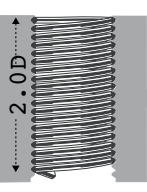
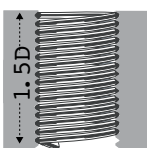
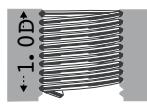



GROUP	PCWI
INSERT TYPE	WIRE THREAD
INSERT MATERIAL	304 STAINLESS STEEL
STYLE	FREE RUNNING



UNF

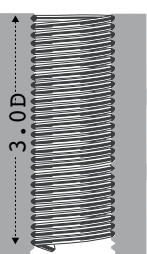
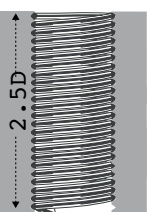
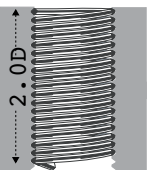
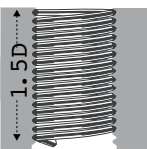

UNF		1.0D BULK INSERT		1.5D BULK INSERTS		2.0D BULK INSERTS		2.5D BULK INSERTS		3.0D BULK INSERTS	
INCH	TPI	INCH	PART #	INCH	PART #	INCH	PART #				
3G	56	0.10	3534-3GX1.0D	0.15	3534-3GX1.5D	0.20	3534-3GX2.0D				
4G	48	0.11	3534-4GX1.0D	0.17	3534-4GX1.5D	0.22	3534-4GX2.0D	0.28	3534-4GX2.5D	0.33	3534-4GX3.0D
6G	40	0.14	3534-6GX1.0D	0.21	3534-6GX1.5D	0.28	3534-6GX2.0D	0.35	3534-6GX2.5D	0.42	3534-6GX3.0D
8G	36	0.16	3534-8GX1.0D	0.24	3534-8GX1.5D	0.32	3534-8GX2.0D	0.40	3534-8GX2.5D	0.48	3534-8GX3.0D
10G	32	0.19	3534-10GX1.0D	0.29	3534-10GX1.5D	0.38	3534-10GX2.0D	0.48	3534-10GX2.5D	0.57	3534-10GX3.0D
12G	28	0.22	3534-12GX1.0D	0.32	3534-12GX1.5D	0.43	3534-12GX2.0D	0.54	3534-12GX2.5D	0.65	3534-12GX3.0D
1/4	28	0.25	3534-1/4X1.0D	0.38	3534-1/4X1.5D	0.50	3534-1/4X2.0D	0.63	3534-1/4X2.5D	0.75	3534-1/4X3.0D
5/16	24	0.31	3534-5/16X1.0D	0.47	3534-5/16X1.5D	0.62	3534-5/16X2.0D	0.78	3534-5/16X2.5D	0.93	3534-5/16X3.0D
3/8	24	0.38	3534-3/8X1.0D	0.57	3534-3/8X1.5D	0.76	3534-3/8X2.0D	0.95	3534-3/8X2.5D	1.14	3534-3/8X3.0D
7/16	20	0.44	3534-7/16X1.0D	0.66	3534-7/16X1.5D	0.88	3534-7/16X2.0D	1.10	3534-7/16X2.5D	1.32	3534-7/16X3.0D
1/2	20	0.50	3534-1/2X1.0D	0.75	3534-1/2X1.5D	1.00	3534-1/2X2.0D	1.25	3534-1/2X2.5D	1.50	3534-1/2X3.0D
9/16	18	0.56	3534-9/16X1.0D	0.84	3534-9/16X1.5D	1.12	3534-9/16X2.0D	1.40	3534-9/16X2.5D	1.68	3534-9/16X3.0D
5/8	18	0.63	3534-5/8X1.0D	0.95	3534-5/8X1.5D	1.26	3534-5/8X2.0D	1.58	3534-5/8X2.5D	1.89	3534-5/8X3.0D
3/4	16	0.75	3534-3/4X1.0D	1.13	3534-3/4X1.5D	1.50	3534-3/4X2.0D	1.88	3534-3/4X2.5D	2.25	3534-3/4X3.0D
7/8	14	0.88	3534-7/8X1.0D	1.32	3534-7/8X1.5D	1.76	3534-7/8X2.0D	2.20	3534-7/8X2.5D	2.64	3534-7/8X3.0D
1	12	1.00	3534-1X1.0D	1.50	3534-1X1.5D	2.00	3534-1X2.0D	2.50	3534-1X2.5D	3.00	3534-1X3.0D
1	14			1.50	3535-1X1.5D						
1-1/8	12			1.70	3534-1.1/8X1.5D						
1-1/4	12			1.88	3534-1.1/4X1.5D						
1-3/8	12			2.07	3534-1.3/8X1.5D						
1-1/2	12			2.25	3534-1.1/2X1.5D						







Spark Plug, NPT, 8-UN

GROUP	PCWI
INSERT TYPE	WIRE THREAD
INSERT MATERIAL	304 STAINLESS STEEL
STYLE	FREE RUNNING



SPARK PLUGS- BULK INSERTS







			
MM	MM		PART #
DIAMETER	PITCH	UNIFIED LENGTH	
10.00	1.00	0.339"	3522-10.00X.339
10.00	1.00	1/2"	3522-10.00X1/2
12.00	1.25	1/2"	3522-12.00X1/2
12.00	1.25	3/4"	3522-12.00X3/4
14.00	1.25	3/8"	3522-14.00X3/8
14.00	1.25	7/16"	3522-14.00X7/16
14.00	1.25	1/2"	3522-14.00X1/2
14.00	1.25	3/4"	3522-14.00X3/4
18.00	1.50	1/2"	3522-18.00X1/2
DIAMETER	PITCH	METRIC LENGTH	
14.00	1.25	8.4MM	3522-14.00X8.4
14.00	1.25	12.4MM	3522-14.00X12.4
14.00	1.25	16.4MM	3522-14.00X16.4

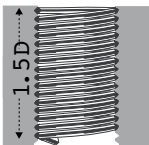

NPT



NPT - BULK INSERTS

			 LENGTH
INCH	TPI	INCH	PART #
1/16	27	0.271	3552-1/16X.271
1/8	27	0.273	3552-1/8X.273
1/4	18	0.394	3552-1/4X.394
3/8	18	0.407	3552-3/8X.407
1/2	14	0.534	3552-1/2X.534
3/4	14	0.553	3552-3/4X.553
1	11.5	0.661	3552-1X.661

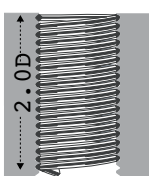
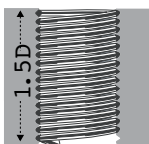









8-UN - BULK INSERTS

1.0D BULK INSERTS

1.5D BULK INSERTS

2.0D BULK INSERTS

			 1.0D		 1.5D		 2.0D
INCH	TPI	INCH	PART #	INCH	PART #	INCH	PART #
1-1/8	8	1.13	3570-1.1/8X1.0D	1.69	3570-1.1/8X1.5D	2.25	3570-1.1/8X2.0D
1-1/4	8	1.25	3570-1.1/4X1.0D	1.88	3570-1.1/4X1.5D	2.50	3570-1.1/4X2.0D
1-3/8	8	1.38	3570-1.3/8X1.0D	2.06	3570-1.3/8X1.5D	2.75	3570-1.3/8X2.0D
1-1/2	8	1.50	3570-1.1/2X1.0D	2.25	3570-1.1/2X1.5D	3.00	3570-1.1/2X2.0D
1-5/8	8	1.63	3570-1.5/8X1.0D	2.44	3570-1.5/8X1.5D	3.25	3570-1.5/8X2.0D
1-3/4	8	1.75	3570-1.3/4X1.0D	2.63	3570-1.3/4X1.5D	3.50	3570-1.3/4X2.0D
1-7/8	8	1.88	3570-1.7/8X1.0D	2.81	3570-1.7/8X1.5D	3.75	3570-1.7/8X2.0D
2	8	2.00	3570-2X1.0D	3.00	3570-2X1.5D	4.00	3570-2X2.0D



GROUP	PCIR
INSERT TYPE	WIRE THREAD
INSERT MATERIAL	304 STAINLESS STEEL
STYLE	FREE RUNNING

METRIC							
MM	MM	INSTALLED LENGTH	#	PART #	PART #	PART #	
2.20	0.45	1.0D	2.20MM	1000	3520-2.20X1.0DSF	—	—
2.20	0.45	1.5D	3.30MM	1000	—	3520-2.20X1.5DSF	—
2.20	0.45	2.0D	4.40MM	1000	—	—	3520-2.20X2.0DSF
2.50	0.45	1.0D	2.50MM	1000	3520-2.50X1.0DSF	—	—
2.50	0.45	1.5D	3.75MM	1000	—	3520-2.50X1.5DSF	—
2.50	0.45	2.0D	5.00MM	1000	—	—	3520-2.50X2.0DSF
3.00	0.50	1.0D	3.00MM	1000	3520-3.00X1.0DSF	—	—
3.00	0.50	1.5D	4.50MM	1000	—	3520-3.00X1.5DSF	—
3.00	0.50	2.0D	6.00MM	1000	—	—	3520-3.00X2.0DSF
4.00	0.70	1.0D	4.00MM	1000	3520-4.00X1.0DSF	—	—
4.00	0.70	1.5D	6.00MM	1000	—	3520-4.00X1.5DSF	—
4.00	0.70	2.0D	8.00MM	1000	—	—	3520-4.00X2.0DSF
5.00	0.80	1.0D	5.00MM	1000	3520-5.00X1.0DSF	—	—
5.00	0.80	1.5D	7.50MM	1000	—	3520-5.00X1.5DSF	—
5.00	0.80	2.0D	10.00MM	1000	—	—	3520-5.00X2.0DSF
6.00	1.00	1.0D	6.00MM	500	3520-6.00X1.0DSF	—	—
6.00	1.00	1.5D	9.00MM	500	—	3520-6.00X1.5DSF	—
6.00	1.00	2.0D	12.00MM	500	—	—	3520-6.00X2.0DSF
8.00	1.00	1.0D	8.00MM	250	3521-8.00X1.0DSF	—	—
8.00	1.00	1.5D	12.00MM	250	—	3521-8.00X1.5DSF	—
8.00	1.00	2.0D	16.00MM	250	—	—	3521-8.00X2.0DSF
8.00	1.25	1.0D	8.00MM	250	3520-8.00X1.0DSF	—	—
8.00	1.25	1.5D	12.00MM	250	—	3520-8.00X1.5DSF	—
8.00	1.25	2.0D	16.00MM	250	—	—	3520-8.00X2.0DSF
10.00	1.50	1.0D	10.00MM	250	3520-10.00X1.0DSF	—	—
10.00	1.50	1.5D	15.00MM	250	—	3520-10.00X1.5DSF	—
10.00	1.50	2.0D	20.00MM	250	—	—	3520-10.00X2.0DSF
12.00	1.75	1.0D	12.00MM	125	3520-12.00X1.0DSF	—	—
12.00	1.75	1.5D	18.00MM	125	—	3520-12.00X1.5DSF	—
12.00	1.75	2.0D	24.00MM	125	—	—	3520-12.00X2.0DSF



MC
MF

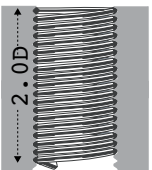
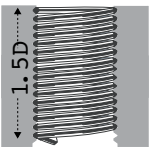



UNC & UNF

1.0D, 1.5D, 2.0D

GROUP	PCIR
INSERT TYPE	WIRE THREAD
INSERT MATERIAL	304 STAINLESS STEEL
STYLE	FREE RUNNING



UNC							
INCH	TPI	INSTALLED LENGTH	#	PART #	PART #	PART #	PART #
2G	56	1.0D	0.09"	1000	3532-2GX1.0DSF	-	-
2G	56	1.5D	0.13"	1000	-	3532-2GX1.5DSF	-
2G	56	2.0D	0.17"	1000	-	-	3532-2GX2.0DSF
4G	40	1.0D	0.11"	1000	3532-4GX1.0DSF	-	-
4G	40	1.5D	0.17"	1000	-	3532-4GX1.5DSF	-
4G	40	2.0D	0.22"	1000	-	-	3532-4GX2.0DSF
5G	40	1.0D	0.13"	1000	3532-5GX1.0DSF	-	-
5G	40	1.5D	0.19"	1000	-	3532-5GX1.5DSF	-
5G	40	2.0D	0.25"	1000	-	-	3532-5GX2.0DSF
6G	32	1.0D	0.14"	1000	3532-6GX1.0DSF	-	-
6G	32	1.5D	0.21"	1000	-	3532-6GX1.5DSF	-
6G	32	2.0D	0.28"	1000	-	-	3532-6GX2.0DSF
8G	32	1.0D	0.16"	1000	3532-8GX1.0DSF	-	-
8G	32	1.5D	0.25"	1000	-	3532-8GX1.5DSF	-
8G	32	2.0D	0.33"	1000	-	-	3532-8GX2.0DSF
10G	24	1.0D	0.19"	1000	3532-10GX1.0DSF	-	-
10G	24	1.5D	0.29"	1000	-	3532-10GX1.5DSF	-
10G	24	2.0D	0.38"	1000	-	-	3532-10GX2.0DSF
12G	24	1.0D	0.22"	500	3532-12GX1.0DSF	-	-
12G	24	1.5D	0.32"	500	-	3532-12GX1.5DSF	-
12G	24	2.0D	0.43"	500	-	-	3532-12GX2.0DSF
1/4	20	1.0D	0.25"	500	3532-1/4X1.0DSF	-	-
1/4	20	1.5D	0.38"	500	-	3532-1/4X1.5DSF	-
1/4	20	2.0D	0.50"	500	-	-	3532-1/4X2.0DSF
5/16	18	1.0D	0.31"	250	3532-5/16X1.0DSF	-	-
5/16	18	1.5D	0.47"	250	-	3532-5/16X1.5DSF	-
5/16	18	2.0D	0.62"	250	-	-	3532-5/16X2.0DSF
3/8	16	1.0D	0.38"	250	3532-3/8X1.0DSF	-	-
3/8	16	1.5D	0.57"	250	-	3532-3/8X1.5DSF	-
3/8	16	2.0D	0.76"	250	-	-	3532-3/8X2.0DSF
UNF							
4G	48	1.0D	0.11"	1000	3534-4GX1.0DSF	-	-
4G	48	1.5D	0.17"	1000	-	3534-4GX1.5DSF	-
4G	48	2.0D	0.22"	1000	-	-	3534-4GX2.0DSF
6G	40	1.0D	0.14"	1000	3534-6GX1.0DSF	-	-
6G	40	1.5D	0.21"	1000	-	3534-6GX1.5DSF	-
6G	40	2.0D	0.28"	1000	-	-	3534-6GX2.0DSF
8G	36	1.0D	0.16"	1000	3534-8GX1.0DSF	-	-
8G	36	1.5D	0.25"	1000	-	3534-8GX1.5DSF	-
8G	36	2.0D	0.33"	1000	-	-	3534-8GX2.0DSF
10G	32	1.0D	0.19"	1000	3534-10GX1.0DSF	-	-
10G	32	1.5D	0.29"	1000	-	3534-10GX1.5DSF	-
10G	32	2.0D	0.38"	1000	-	-	3534-10GX2.0DSF
1/4	28	1.0D	0.25"	500	3534-1/4X1.0DSF	-	-
1/4	28	1.5D	0.38"	500	-	3534-1/4X1.5DSF	-
1/4	28	2.0D	0.50"	500	-	-	3534-1/4X2.0DSF
5/16	24	1.0D	0.31"	250	3534-5/16X1.0DSF	-	-
5/16	24	1.5D	0.47"	250	-	3534-5/16X1.5DSF	-
5/16	24	2.0D	0.62"	250	-	-	3534-5/16X2.0DSF
3/8	24	1.0D	0.38"	250	3534-3/8X1.0DSF	-	-
3/8	24	1.5D	0.57"	250	-	3534-3/8X1.5DSF	-
3/8	24	2.0D	0.76"	250	-	-	3534-3/8X2.0DSF



UNC
UNF

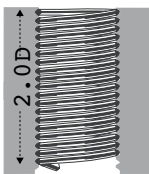
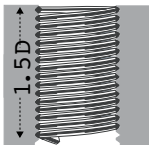

GROUP	PCTP	PCTP
MATERIAL	HSS	HSSE
TOLERANCE	4H5H	4H5H
TYPE	STI	STI

METRIC COARSE – STI TAPS

MM	MM	MM	PART #	PART #	PART #	PART #	PART #
2.00	0.40	44.50	3520-2.00T	3520-2.00I	3520-2.00B	3520-2.00SP	3520-2.00SF
2.20	0.45	44.50	3520-2.20T	3520-2.20I	3520-2.20B	3520-2.20SP	3520-2.20SF
2.50	0.45	48.00	3520-2.50T	3520-2.50I	3520-2.50B	3520-2.50SP	3520-2.50SF
3.00	0.50	53.00	3520-3.00T	3520-3.00I	3520-3.00B	3520-3.00SP	3520-3.00SF
3.50	0.60	53.00	3520-3.50T	3520-3.50I	3520-3.50B	3520-3.50SP	3520-3.50SF
4.00	0.70	58.00	3520-4.00T	3520-4.00I	3520-4.00B	3520-4.00SP	3520-4.00SF
5.00	0.80	66.00	3520-5.00T	3520-5.00I	3520-5.00B	3520-5.00SP	3520-5.00SF
6.00	1.00	72.00	3520-6.00T	3520-6.00I	3520-6.00B	3520-6.00SP	3520-6.00SF
7.00	1.00	72.00	3520-7.00T	3520-7.00I	3520-7.00B	3520-7.00SP	3520-7.00SF
8.00	1.25	80.00	3520-8.00T	3520-8.00I	3520-8.00B	3520-8.00SP	3520-8.00SF
9.00	1.25	85.00	3520-9.00T	3520-9.00I	3520-9.00B	-	-
10.00	1.50	89.00	3520-10.00T	3520-10.00I	3520-10.00B	3520-10.00SP	3520-10.00SF
11.00	1.50	89.00	3520-11.00T	3520-11.00I	3520-11.00B	3520-11.00SP	3520-11.00SF
12.00	1.75	95.00	3520-12.00T	3520-12.00I	3520-12.00B	3520-12.00SP	3520-12.00SF
13.00	1.75	95.00	3520-13.00T	3520-13.00I	3520-13.00B	-	-
14.00	2.00	102.00	3520-14.00T	3520-14.00I	3520-14.00B	3520-14.00SP	3520-14.00SF
15.00	2.00	112.00	3520-15.00T	3520-15.00I	3520-15.00B	-	-
16.00	2.00	112.00	3520-16.00T	3520-16.00I	3520-16.00B	3520-16.00SP	3520-16.00SF
18.00	2.50	118.00	3520-18.00T	3520-18.00I	3520-18.00B	3520-18.00SP	3520-18.00SF
20.00	2.50	118.00	3520-20.00T	3520-20.00I	3520-20.00B	3520-20.00SP	3520-20.00SF
22.00	2.50	130.00	3520-22.00T	3520-22.00I	3520-22.00B	3520-22.00SP	3520-22.00SF
24.00	3.00	138.00	3520-24.00T	3520-24.00I	3520-24.00B	3520-24.00SP	3520-24.00SF
27.00	3.00	151.00	-	3520-27.00I	-	-	-
30.00	3.50	162.00	-	3520-30.00I	-	3520-30.00SP	3520-30.00SF
33.00	3.50	162.00	-	3520-33.00I	-	3520-33.00SP	3520-33.00SF
36.00	4.00	170.00	-	3520-36.00I	-	-	-

GROUP	PCTP	PCTP
MATERIAL	HSS	HSSE
TOLERANCE	4H5H	4H5H
TYPE	STI	STI



METRIC FINE – STI TAPS

MM	MM	MM	PART #	PART #	PART #	PART #	PART #
8.00	1.00	80.00	3521-8.00T	3521-8.00I	3521-8.00B	3521-8.00SP	3521-8.00SF
10.00	1.25	85.00	3521-10.00T	3521-10.00I	3521-10.00B	3521-10.00SP	3521-10.00SF
10.00	1.00	85.00	3523-10.00T	3523-10.00I	3523-10.00B	3523-10.00SP	3523-10.00SF
11.00	1.25	88.00	3521-11.00T	3521-11.00I	3521-11.00B	-	-
11.00	1.00	88.00	3523-11.00T	3523-11.00I	3523-11.00B	-	-
12.00	1.50	95.00	3521-12.00T	3521-12.00I	3521-12.00B	3521-12.00SP	3521-12.00SF
12.00	1.25	95.00	3523-12.00T	3523-12.00I	3523-12.00B	3523-12.00SP	3523-12.00SF
12.00	1.00	95.00	3524-12.00T	3524-12.00I	3524-12.00B	-	-
13.00	1.25	95.00	3523-13.00T	3523-13.00I	3523-13.00B	-	-
14.00	1.50	102.00	3521-14.00T	3521-14.00I	3521-14.00B	3521-14.00SP	3521-14.00SF
14.00	1.25	102.00	3523-14.00T	3523-14.00I	3523-14.00B	3523-14.00SP	3523-14.00SF
14.00	1.00	102.00	3524-14.00T	3524-14.00I	3524-14.00B	-	-
15.00	1.50	104.00	3521-15.00T	3521-15.00I	3521-15.00B	-	-
16.00	1.50	104.00	3521-16.00T	3521-16.00I	3521-16.00B	-	-
18.00	2.00	104.00	3521-18.00T	3521-18.00I	3521-18.00B	-	-
18.00	1.50	104.00	3523-18.00T	3523-18.00I	3523-18.00B	-	-
20.00	2.00	113.00	3521-20.00T	3521-20.00I	3521-20.00B	-	-
20.00	1.50	113.00	3523-20.00T	3523-20.00I	3523-20.00B	-	-
22.00	2.00	120.00	3521-22.00T	3521-22.00I	3521-22.00B	-	-
22.00	1.50	120.00	3523-22.00T	3523-22.00I	3523-22.00B	-	-
24.00	2.00	127.00	3521-24.00T	3521-24.00I	3521-24.00B	-	-
24.00	1.50	120.00	3523-24.00T	3523-24.00I	3523-24.00B	-	-
26.00	1.50	127.00	3523-26.00T	3523-26.00I	3523-26.00B	-	-
27.00	2.00	127.00	3521-27.00T	3521-27.00I	3521-27.00B	-	-
27.00	1.50	127.00	3523-27.00T	3523-27.00I	3523-27.00B	-	-
28.00	1.50	127.00	3523-28.00T	3523-28.00I	3523-28.00B	-	-
30.00	2.00	137.00	3521-30.00T	3521-30.00I	3521-30.00B	-	-
30.00	1.50	137.00	3523-30.00T	3523-30.00I	3523-30.00B	-	-
33.00	2.00	144.00	3521-33.00T	3521-33.00I	3521-33.00B	-	-
36.00	3.00	170.00	3521-36.00T	3521-36.00I	3521-36.00B	-	-
36.00	2.00	150.00	3523-36.00T	3523-36.00I	3523-36.00B	-	-
36.00	1.50	150.00	3524-36.00T	3524-36.00I	3524-36.00B	-	-

SPARK PLUG – PILOT NOSE STI TAPS

MM	MM	MM	PART #
6.00	1.00	70.00	3520-6.00PN
8.00	1.25	75.00	3520-8.00PN
10.00	1.50	80.00	3520-10.00PN
10.00	1.00	74.00	3522-10.00PN
12.00	1.25	75.00	3522-12.00PN
14.00	1.25	90.00	3522-14.00PN
18.00	1.50	116.00	3522-18.00PN



GROUP	PCTP	PCTP
MATERIAL	HSS	HSSE
TOLERANCE	3B	3B
TYPE	STI	STI



UNC – STI TAPS

INCH	TPI	MM	PART #	PART #	PART #	PART #	PART #	PART #	PART #	PART #	PART #	PART #	PART #
2G	56	48.00	3532-2GT	3532-2GI	3532-2GB	3532-2GSP	3532-2GSF						
3G	48	48.00	3532-3GT	3532-3GI	3532-3GB	3532-3GSP	3532-3GSF						
4G	40	53.00	3532-4GT	3532-4GI	3532-4GB	3532-4GSP	3532-4GSF						
5G	40	53.00	3532-5GT	3532-5GI	3532-5GB	3532-5GSP	3532-5GSF						
6G	32	58.00	3532-6GT	3532-6GI	3532-6GB	3532-6GSP	3532-6GSF						
8G	32	62.00	3532-8GT	3532-8GI	3532-8GB	3532-8GSP	3532-8GSF						
10G	24	66.00	3532-10GT	3532-10GI	3532-10GB	3532-10GSP	3532-10GSF						
12G	24	66.00	3532-12GT	3532-12GI	3532-12GB	3532-12GSP	3532-12GSF						
1/4	20	72.00	3532-1/4T	3532-1/4I	3532-1/4B	3532-1/4SP	3532-1/4SF						
5/16	18	80.00	3532-5/16T	3532-5/16I	3532-5/16B	3532-5/16SP	3532-5/16SF						
3/8	16	85.00	3532-3/8T	3532-3/8I	3532-3/8B	3532-3/8SP	3532-3/8SF						
7/16	14	95.00	3532-7/16T	3532-7/16I	3532-7/16B	3532-7/16SP	3532-7/16SF						
1/2	13	102.00	3532-1/2T	3532-1/2I	3532-1/2B	3532-1/2SP	3532-1/2SF						
9/16	12	112.00	3532-9/16T	3532-9/16I	3532-9/16B	-	-						
5/8	11	112.00	3532-5/8T	3532-5/8I	3532-5/8B	3532-5/8SP	3532-5/8SF						
3/4	10	118.00	3532-3/4T	3532-3/4I	3532-3/4B	3532-3/4SP	3532-3/4SF						
7/8	9	130.00	3532-7/8T	3532-7/8I	3532-7/8B	3532-7/8SP	3532-7/8SF						
1	8	138.00	3532-1T	3532-1I	3532-1B	3532-1SP	3532-1SF						
1-1/8	7	151.00	3532-1.1/8T	3532-1.1/8I	3532-1.1/8B	-	-						
1-1/4	7	162.00	3532-1.1/4T	3532-1.1/4I	3532-1.1/4B	-	-						
1-3/8	6	170.00	3532-1.3/8T	3532-1.3/8I	3532-1.3/8B	-	-						
1-1/2	6	187.00	3532-1.1/2T	3532-1.1/2I	3532-1.1/2B	-	-						

UNF – STI TAPS

INCH	TPI	MM	PART #	PART #	PART #	PART #	PART #	PART #	PART #	PART #	PART #	PART #	PART #
3G	56	48.00	3534-3GT	3534-3GI	3534-3GB	3534-3GSP	3534-3GSF						
4G	48	53.00	3534-4GT	3534-4GI	3534-4GB	3534-4GSP	3534-4GSF						
6G	40	53.00	3534-6GT	3534-6GI	3534-6GB	3534-6GSP	3534-6GSF						
8G	36	62.00	3534-8GT	3534-8GI	3534-8GB	3534-8GSP	3534-8GSF						
10G	32	66.00	3534-10GT	3534-10GI	3534-10GB	3534-10GSP	3534-10GSF						
12G	28	66.00	3534-12GT	3534-12GI	3534-12GB	3534-12GSP	3534-12GSF						
1/4	28	69.00	3534-1/4T	3534-1/4I	3534-1/4B	3534-1/4SP	3534-1/4SF						
5/16	24	76.00	3534-5/16T	3534-5/16I	3534-5/16B	3534-5/16SP	3534-5/16SF						
3/8	24	82.00	3534-3/8T	3534-3/8I	3534-3/8B	3534-3/8SP	3534-3/8SF						
7/16	20	84.00	3534-7/16T	3534-7/16I	3534-7/16B	3534-7/16SP	3534-7/16SF						
1/2	20	90.00	3534-1/2T	3534-1/2I	3534-1/2B	3534-1/2SP	3534-1/2SF						
9/16	18	104.00	3534-9/16T	3534-9/16I	3534-9/16B	3534-9/16SP	3534-9/16SF						
5/8	18	104.00	3534-5/8T	3534-5/8I	3534-5/8B	3534-5/8SP	3534-5/8SF						
3/4	16	104.00	3534-3/4T	3534-3/4I	3534-3/4B	3534-3/4SP	3534-3/4SF						
7/8	14	120.00	3534-7/8T	3534-7/8I	3534-7/8B	3534-7/8SP	3534-7/8SF						
1	12	127.00	3534-1T	3534-1I	3534-1B	3534-1SP	3534-1SF						
1	14	127.00	3535-1T	3535-1I	3535-1B	3535-1SP	3535-1SF						
1-1/8	12	137.00	3534-1.1/8T	3534-1.1/8I	3534-1.1/8B	-	-						
1-1/4	12	144.00	3534-1.1/4T	3534-1.1/4I	3534-1.1/4B	-	-						
1-3/8	12	150.00	3534-1.3/8T	3534-1.3/8I	3534-1.3/8B	-	-						
1-1/2	12	150.00	3534-1.1/2T	3534-1.1/2I	3534-1.1/2B	-	-						



NPT, 8-UN



GROUP	PCTP
MATERIAL	HSS
TOLERANCE	3B
TYPE	STI

NPT – STI TAPS

INCH	TPI	MM	PART #	PART #	PART #
1/8	27	54.00	3552-1/8T	3552-1/8I	3552-1/8B
1/4	18	62.00	3552-1/4T	3552-1/4I	3552-1/4B
3/8	18	65.00	3552-3/8T	3552-3/8I	3552-3/8B
1/2	14	80.00	3552-1/2T	3552-1/2I	3552-1/2B
3/4	14	83.00	3552-3/4T	3552-3/4I	3552-3/4B
1	11.5	95.00	3552-1T	3552-1I	3552-1B

8-UN – STI TAPS

INCH	TPI	MM	PART #	PART #	PART #
1-1/8	8	151.00	3570-1.1/8T	3570-1.1/8I	3570-1.1/8B
1-1/4	8	162.00	3570-1.1/4T	3570-1.1/4I	3570-1.1/4B
1-3/8	8	170.00	3570-1.3/8T	3570-1.3/8I	3570-1.3/8B
1-1/2	8	170.00	3570-1.1/2T	3570-1.1/2I	3570-1.1/2B
1-5/8	8	187.00	3570-1.5/8T	3570-1.5/8I	3570-1.5/8B
1-3/4	8	187.00	3570-1.3/4T	3570-1.3/4I	3570-1.3/4B
1-7/8	8	200.00	3570-1.7/8T	3570-1.7/8I	3570-1.7/8B
2	8	200.00	3570-2T	3570-2I	3570-2B



GROUP	PCIT
USAGE	GENERAL
INSERT TYPE	WIRE THREAD
INSERT STYLE	FREE RUNNING
APPLICATION	LOW VOLUME

HAND INSTALLATION TOOLS – HIT												
MC	MF	SPARK	UNC	UNF	BSW	BSF	BA	BSC	NPT	BSP	UN-8	PART #
2X0.40	-	-	-	-	-	-	-	-	-	-	-	3500-HIT2
	-	-	2GX56	-	-	-	-	-	-	-	-	3500-HIT2
	-	-	3GX48	3GX56	-	-	#6	-	-	-	-	3500-HIT3
3X0.50	-	-	4GX40	4GX48	1/8X40	-	-	-	-	-	-	3500-HIT4
	-	-	5GX40	-	-	-	-	-	-	-	-	3500-HIT4
	-	-	6GX32	6GX40	-	-	#4	-	-	-	-	3500-HIT5
4X0.70	-	-	8GX32	8GX36	-	-	-	-	-	-	-	3500-HIT6
5X0.80	-	-	12GX24	10GX32	-	3/16X32	#1	-	-	-	-	3500-HIT8
6X1.00	-	-	1/4X20	1/4X28	1/4X20	1/4X26	#0	1/4X26	-	-	-	3500-HIT9
7X1.00	-	-	5/16X18	-	5/16X18	-	-	-	1/16X27	-	-	3500-HIT10
8X1.25	8X1.00	-	-	5/16X24	3/8X16	5/16X22	-	5/16X26	-	-	-	3500-HIT11
9X1.25	10X1.25	10X1.00	3/8X16	3/8X24	-	3/8X20	-	3/8X26	-	-	-	3500-HIT13
9X1.00	10X1.00	-	-	-	-	-	-	-	-	-	-	3500-HIT13
10X1.50	-	-	-	-	-	-	-	-	1/8X27	-	-	3500-HIT13
11X1.50	11X1.25	-	7/16X14	7/16X20	7/16X14	7/16X18	-	7/16X26	-	1/8X28	-	3500-HIT14
	11X1.00	-	-	-	-	-	-	-	-	-	-	3500-HIT14
12X1.75	12X1.50	10X1.25	1/2X13	1/2X20	1/2X12	1/2X16	-	1/2X26	-	-	-	3500-HIT15
12X1.00	12X1.25	-	-	-	-	-	-	-	-	-	-	3500-HIT15
14X2.00	14X1.00	-	9/16X12	9/16X18	9/16X12	9/16X16	-	-	-	1/4X19	-	3500-HIT16
15X2.00	14X1.50	-	-	-	-	-	-	-	1/4X18	-	-	3500-HIT16
	-	14X1.25	-	-	-	-	-	-	-	-	-	3500-HIT17
16X2.00	16X1.50	-	5/8X11	5/8X18	5/8X11	5/8X14	-	-	3/8X18	-	-	3500-HIT18
18X2.50	18X2.00	18X1.50	3/4X10	-	3/4X10	3/4X12	-	-	-	3/8X19	-	3500-HIT20
	18X1.50	-	-	-	-	-	-	-	-	-	-	3500-HIT20
20X2.50	20X2.00	-	-	3/4X16	-	-	-	-	-	-	-	3500-HIT21
	20X1.50	-	-	-	-	-	-	-	-	-	-	3500-HIT21
22X2.50	22X2.00	-	7/8X9	7/8X14	7/8X9	7/8X11	-	-	1/2X14	-	-	3500-HIT22
	22X1.50	-	-	-	-	-	-	-	-	-	-	3500-HIT22
24X3.00	24X2.00	-	1X8	1X12	1X8	1X10	-	-	-	1/2X14	-	3500-HIT23
	24X1.50	-	-	1X14	-	-	-	-	-	5/8X14	-	3500-HIT23
27X3.00	26X1.50	-	-	-	-	-	-	-	3/4X14	3/4X14	-	3500-HIT24
30X3.00	-	-	1.1/8-7	1.1/8-12	-	-	-	-	-	-	1.1/8X8	3500-HIT25
33X3.50	30X2.00	-	1.1/4-7	1.1/4-12	-	-	-	-	-	-	1.1/4X8	3500-HIT26
	-	-	1.3/8-6	1.3/8-12	-	-	-	-	1X11.5	7/8X14	1.3/8X8	3500-HIT27
	-	-	-	-	-	-	-	-	-	1X11	-	3500-HIT27
36X4.00	36X2.00	-	1.1/2-6	1.1/2-12	-	-	-	-	-	-	1.1/2X8	3500-HIT28
	-	-	-	-	-	-	-	-	-	-	1.5/8X8	3500-HIT28
	-	-	-	-	-	-	-	-	-	-	1.3/4X8	3500-HIT28
	-	-	-	-	-	-	-	-	-	-	1.7/8X8	3500-HIT30
	-	-	-	-	-	-	-	-	-	-	2X8	3500-HIT30

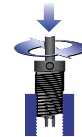



GROUP	PCIT
USAGE	GENERAL
INSERT TYPE	WIRE THREAD
INSERT STYLE	ALL
APPLICATION	LOW VOLUME

Break, Removal



TANG BREAK TOOLS – TB : INSERT REMOVAL TOOLS – RT

MC	MF	SPARK	UNC	UNF	BSW	BSF	BA	BSC	PART #	PART #
2X0.40	-	-	-	-	-	-	-	-	3500-TB1	3500-RT1
2.20X0.45	-	-	2GX56	-	-	-	-	-	3500-TB2	3500-RT1
2.50X0.45	-	-	3GX48	3GX56	-	-	#6	-	3500-TB3	3500-RT1
-	-	-	4GX40	4GX48	1/8X40	-	-	-	3500-TB4	3500-RT1
3X0.50	-	-	-	4GX48	-	-	-	-	3500-TB4	3500-RT2
-	-	-	5GX40	-	-	-	-	-	3500-TB4	3500-RT1
3.50X0.60	-	-	-	-	-	-	-	-	3500-TB5	3500-RT2
-	-	-	6GX32	6GX40	-	-	#4	-	3500-TB5	3500-RT1
4X0.70	-	-	-	-	-	3/16X32	-	-	3500-TB6	3500-RT2
-	-	-	8GX32	8GX36	-	-	-	-	3500-TB6	3500-RT1
5X0.80	-	-	10GX24	10GX32	3/16X24	-	#2	-	3500-TB8	3500-RT2
-	-	-	12GX24	12GX28	-	-	-	-	3500-TB8	3500-RT2
6X1.00	-	-	1/4X20	1/4X28	1/4X20	1/4X26	-	1/4X26	3500-TB9	3500-RT2
7X1.00	-	-	-	-	5/16X18	5/16X22	#0	-	3500-TB11	3500-RT2
8X1.25	8X1.00	-	5/16X18	5/16X24	-	-	-	5/16X26	3500-TB12	3500-RT2
9X1.25	9X1.00	10X1.00	-	-	-	-	-	-	3500-TB12	3500-RT2
-	-	-	3/8X16	-	3/8X16	3/8X20	-	-	3500-TB12	3500-RT3
10X1.50	10X1.25	-	-	-	-	-	-	-	3500-TB13	3500-RT2
-	-	-	-	3/8X24	-	-	-	3/8X26	3500-TB13	3500-RT3
-	10X1.00	-	-	-	-	-	-	-	3500-TB13	3500-RT2
11X1.50	11X1.25	-	7/16X14	7/16X20	7/16X14	7/16X18	-	7/16X26	3500-TB14	3500-RT3
-	11X1.00	-	-	-	-	-	-	-	3500-TB14	3500-RT3
12X1.75	12X1.50	10X1.25	1/2X13	1/2X20	1/2X12	1/2X16	-	1/2X26	3500-TB15	3500-RT3
-	12X1.00	12X1.25	-	-	-	-	-	-	3500-TB15	3500-RT3
13X1.75	13X1.50	-	-	-	-	-	-	-	3500-TB15	3500-RT3
-	13X1.25	-	-	-	-	-	-	-	-	3500-RT3
14X2.00	14X1.50	14X1.25	9/16X12	9/16X18	9/16X12	9/16X16	-	-	-	3500-RT3
-	14X1.00	-	-	-	-	-	-	-	-	3500-RT3
15X2.00	15X1.50	-	-	-	-	-	-	-	-	3500-RT3
16X2.00	16X1.50	-	5/8X11	5/8X18	5/8X11	5/8X14	-	-	-	3500-RT3
18X2.50	18X2.00	18X1.50	3/4X10	-	3/4X10	3/4X12	-	-	-	3500-RT3
20X2.50	20X2.00	-	-	3/4X16	-	-	-	-	-	3500-RT3
-	20X1.50	-	-	-	-	-	-	-	-	3500-RT3
22X2.50	22X2.00	-	7/8X9	7/8X14	7/8X9	7/8X11	-	-	-	3500-RT3
-	22X1.50	-	-	-	-	-	-	-	-	3500-RT3
24X3.00	24X2.00	-	1X8	1X12	1X8	1X10	-	-	-	3500-RT3
-	24X1.50	-	-	1X14	-	-	-	-	-	3500-RT3
-	26X1.50	-	-	-	-	-	-	-	-	3500-RT4
27X3.00	27X2.00	-	-	-	-	-	-	-	-	3500-RT4
-	27X1.50	-	-	-	-	-	-	-	-	3500-RT4
-	28X1.50	-	-	-	-	-	-	-	-	3500-RT4
30X3.50	30X2.00	-	1.1/8X7	1.1/8X12	-	-	-	-	-	3500-RT4
-	30X1.50	-	1.1/4X7	1.1/4X12	-	-	-	-	-	3500-RT4
33X3.50	33X2.00	-	1.3/8X6	1.3/8X12	-	-	-	-	-	3500-RT4
36X4.00	36X3.00	-	1.1/2X6	1.1/2X12	-	-	-	-	-	3500-RT4
-	36X2.00	-	-	-	-	-	-	-	-	3500-RT4
-	36X1.50	-	-	-	-	-	-	-	-	3500-RT4







Note: For larger insert sizes, where a TB (Tang Break) tool is not listed, the tang break operation is performed using the HIT (Hand Installation Tool).





GROUP	PCIT
USAGE	GENERAL
INSERT TYPE	WIRE THREAD
INSERT STYLE	ALL
APPLICATION	HIGH VOLUME



PNEUMATIC TOOLS AND FRONT END ASSEMBLIES

					
MC	MF	PART #	PART #	PART #	PART #
2X0.40	-	3520-2.20MIP	3520-2.20MIPM	3520-2.20MIPN	3500-MIP1
2.50X0.45	-	3520-2.50MIP	3520-2.50MIPM	3520-2.50MIPN	3500-MIP1
3X0.50	-	3520-3.00MIP	3520-3.00MIPM	3520-3.00MIPN	3500-MIP1
3.50X0.60	-	3520-3.50MIP	3520-3.50MIPM	3520-3.50MIPN	3500-MIP1
4X0.70	-	3520-4.00MIP	3520-4.00MIPM	3520-4.00MIPN	3500-MIP1
5X0.80	-	3520-5.00MIP	3520-5.00MIPM	3520-5.00MIPN	3500-MIP1
6X1.00	-	3520-6.00MIP	3520-6.00MIPM	3520-6.00MIPN	3500-MIP1
8X1.25	-	3520-8.00MIP	3520-8.00MIPM	3520-8.00MIPN	3500-MIP2
-	8X1.00	3521-8.00MIP	3521-8.00MIPM	3521-8.00MIPN	3500-MIP2
10X1.50	-	3520-10.00MIP	3520-10.00MIPM	3520-10.00MIPN	3500-MIP2
-	10X1.25	3521-10.00MIP	3521-10.00MIPM	3521-10.00MIPN	3500-MIP2
-	10X1.00	3523-10.00MIP	3523-10.00MIPM	3523-10.00MIPN	3500-MIP2
12X1.75	-	3520-12.00MIP	3520-12.00MIPM	3520-12.00MIPN	3500-MIP2
-	12X1.50	3521-12.00MIP	3521-12.00MIPM	3521-12.00MIPN	3500-MIP2
-	12X1.25	3523-12.00MIP	3523-12.00MIPM	3523-12.00MIPN	3500-MIP2

PNEUMATIC TOOLS AND FRONT END ASSEMBLIES

					
UNC	UNF	PART #	PART #	PART #	PART #
2GX56	-	3532-2GMIP	3532-2GMIPM	3532-2GMIPN	3500-MIP1
4GX40	-	3532-4GMIP	3532-4GMIPM	3532-4GMIPN	3500-MIP1
5GX40	-	3532-5GMIP	3532-5GMIPM	3532-5GMIPN	3500-MIP1
6GX32	-	3532-6GMIP	3532-6GMIPM	3532-6GMIPN	3500-MIP1
-	6GX40	3534-6GMIP	3534-6GMIPM	3534-6GMIPN	3500-MIP1
8GX32	-	3532-8GMIP	3532-8GMIPM	3532-8GMIPN	3500-MIP1
-	8GX36	3534-8GMIP	3534-8GMIPM	3534-8GMIPN	3500-MIP1
10GX24	-	3532-10GMIP	3532-10GMIPM	3532-10GMIPN	3500-MIP1
-	10GX32	3534-10GMIP	3534-10GMIPM	3534-10GMIPN	3500-MIP1
12GX24	-	3532-12GMIP	3532-12GMIPM	3532-12GMIPN	3500-MIP1
1/4X20	-	3532-1/4MIP	3532-1/4MIPM	3532-1/4MIPN	3500-MIP1
-	1/4X28	3534-1/4MIP	3534-1/4MIPM	3534-1/4MIPN	3500-MIP1
5/16X18	-	3532-5/16MIP	3532-5/16MIPM	3532-5/16MIPN	3500-MIP2
-	5/16X24	3534-5/16MIP	3534-5/16MIPM	3534-5/16MIPN	3500-MIP2
3/8X16	-	3532-3/8MIP	3532-3/8MIPM	3532-3/8MIPN	3500-MIP2
-	3/8X24	3534-3/8MIP	3534-3/8MIPM	3534-3/8MIPN	3500-MIP2
7/16X14	-	3532-7/16MIP	3532-7/16MIPM	3532-7/16MIPN	3500-MIP2
-	7/16X20	3534-7/16MIP	3534-7/16MIPM	3534-7/16MIPN	3500-MIP2
1/2X13	-	3532-1/2MIP	3532-1/2MIPM	3532-1/2MIPN	3500-MIP2
-	1/2X20	3534-1/2MIP	3534-1/2MIPM	3534-1/2MIPN	3500-MIP2



Front End Assemblies (MIP) include the Mandrel (MIPM), Nozzle (MIPN), spacers to suit 1.0D, 1.5D and 2.0D inserts plus a set of shim washers for fine adjustment of installation depth.

Pneumatic Wire Thread Installation Tools and Front End Assemblies Overview

Detailed instructions are included with every Pneumatic Tool and Front End Assembly.

You will need

- A front-end assembly appropriate to the Wire Thread Inserts you wish to install and the applicable pneumatic tool.
- An air supply providing air pressure up to 100psi (7 bar) incorporating a filtered and lubricated air regulator. Your air supply should also incorporate an isolating switch to stop the air supply to the tool and connectors/couplings.
- PTFE tape should be wound around the threaded end of the air connector prior to screwing into air tool to ensure a good seal.
- If tool is to be used with a work arm assembly please ensure that the instructions supplied with that equipment are read in conjunction with these instructions.

Front-end assembly

The front-end assembly is used in conjunction with the pneumatic installation tool to aid the installation of Wire Thread Inserts. The front-end assembly winds a mandrel through the insert (1.0D, 1.5D or 2.0D) and through the pre-winder nozzle. When the insert emerges from the nozzle the diameter has been reduced (pre-wound) to facilitate easy entry into the prepared and threaded hole in the parent material.

The front-end assembly consists of two main components • Nozzle • Mandrel

Three different mandrel types are used depending on the size of the inserts being installed.

Check that the front-end assembly pack also contains 2 or 3 thickness spacers (to suit different length inserts) and at least 3 shim washers. Wire Thread Inserts should be installed 3/4 to 1-1/2 pitches below the surface of a countersunk hole or 1/4 to 1/2 coil below the surface of a flush hole. The Wire Thread Insert must be fully engaged with the thread in the hole throughout its length.

Separate mandrel from nozzle by rotating the mandrel anti-clockwise until the mandrel disengages. You can now assemble the correct combination of spacers and shims (if necessary) between the clutch seat and nozzle.

Identify the length of the insert to be installed and select spacers to adjust insertion depth eg: for 1.0D inserts select the longest spacer - the longer the insert the shorter the required spacer. Once the spacers and shims have been positioned on the shaft of the mandrel lubricate the mandrel thread with light machine oil and wind the mandrel through the nozzle. Locate the mandrel pin in the slot of the driving spline (inside the adaptor case) and slide the front end assembly into the case. Tighten the retaining ring (anti-clockwise) finger tight only - over tightening will restrict free movement of the mandrel, possibly resulting in damage. The mandrel should always be wound through the nozzle so that the threaded section is fully disengaged prior to assembling the tool.

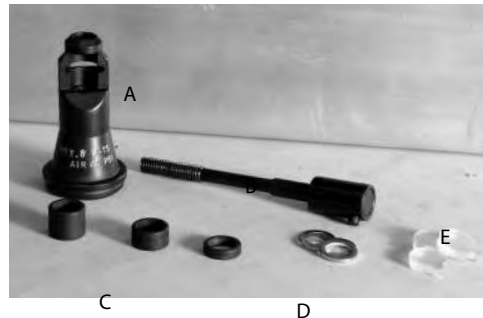

A Nozzle
B Mandrel
C Thickness spacers
D Shim washers
E Cushions
(for use in the adaptor of an ARO® brand pneumatic tool only)



Front end assembly with longest spacer to suit 1.0D insert.



Front end assembly with longest spacer to suit 1.0D insert and shim washer.



Finished front end assembly with mandrel wound through the pre-winder nozzle.



Locate mandrel pin in the slot of the driving spline and slide the front end assembly into the case.



Ensure the front end assembly insert chamber opening is aligned with the trigger of the air motor. Final adjustments may still need to be made (using shim washers) to ensure that the inserts are installed to the optimum depth.

Recommended air pressures

Insert size – inch	#2	#3	#6	#8	#10	1/4"	5/16"	3/8"	7/16"	1/2"
Insert size – metric	M2.0-2.2	M2.5	M3.0	M3.5	M4.0-4.5	M6.0-7.0	M8.0	M10.0	M11.0	M12.0
Recommended pressure – psi	25	25-30	25-30	40	45	50-60	60	70	70-80	90
Recommended pressure – bar	1.7	1.7-2.0	1.7-2.0	2.8	3.0	3.5-4.1	4.1	4.8	4.8-5.5	6.2

PAGE INTENTIONALLY LEFT BLANK



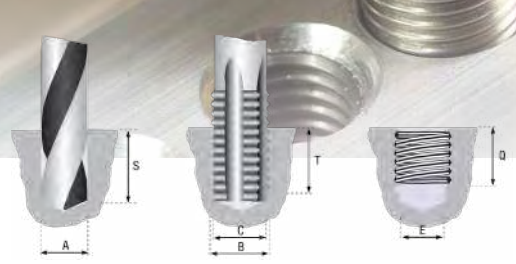

Nominal Thread Size	DRILLED HOLE DIMENSIONS										Nominal Thread Size	TAPPED HOLE DIMENSIONS										E Fitted Minor Dia.	
	Drill				S Min. Drilling Depth Inter/Plug Tap							B Major Dia.	C Pitch Diameter				T Minimum Tapping Depth						
	Size		A Minor Dia.		1D	1.5D	2D	2.5D	3D	Min			5H Max	6H Max	1D	1.5D	2D	2.5D	3D				
	mm	inch	mm	mm	mm	mm	mm	mm	mm	mm			mm	mm	mm	mm	mm	mm	mm				
METRIC										METRIC													
M2 X 0.40	2.10	#45	2.087	2.177	3.80	4.80	5.80	6.80	7.80	M2 X 0.40	2.520	2.260	2.296	2.311	3.40	4.40	5.40	6.40	7.40	1.567			
M2.2 X 0.45	2.30	#42	2.297	2.397	4.23	5.33	6.43	7.53	8.63	M2.2 X 0.45	2.785	2.492	2.532	2.547	3.78	4.88	5.98	7.08	8.18	1.713			
M2.5 X 0.45	2.60	#37	2.597	2.697	4.53	5.78	7.03	8.28	9.53	M2.5 X 0.45	3.085	2.792	2.832	2.847	4.08	5.33	6.58	7.83	9.08	2.013			
M3 X 0.50	3.20	1/8	3.108	3.220	5.25	6.75	8.25	9.75	11.25	M3 X 0.50	3.650	3.325	3.367	3.384	4.75	6.25	7.75	9.25	10.75	2.459			
M3.5 X 0.60	3.70	#27	3.630	3.755	6.20	7.95	9.70	11.45	13.20	M3.5 X 0.60	4.279	3.890	3.940	3.959	5.60	7.35	9.10	10.85	12.60	2.850			
M4 x 0.70	4.20	11/64	4.152	4.292	7.15	9.15	11.15	13.15	15.15	M4 x 0.70	4.909	4.455	4.509	4.529	6.45	8.45	10.45	12.45	14.45	3.242			
M5 X 0.80	5.20	13/64	5.173	5.333	8.60	11.10	13.60	16.10	18.60	M5 X 0.80	6.039	5.520	5.577	5.597	7.80	10.30	12.80	15.30	17.80	4.134			
M6 X 1.00	6.30	1/4	6.216	6.406	10.50	13.50	16.50	19.50	22.50	M6 X 1.00	7.299	6.650	6.719	6.742	9.50	12.50	15.50	18.50	21.50	4.917			
M7 X 1.00	7.30	9/32	7.216	7.406	11.50	15.00	18.50	22.00	25.50	M7 X 1.00	8.299	7.650	7.719	7.742	10.50	14.00	17.50	21.00	24.50	5.917			
M8 X 1.25	8.30	21/64	8.271	8.483	13.63	17.63	21.63	25.63	29.63	M8 X 1.25	9.624	8.812	8.886	8.912	12.38	16.38	20.38	24.38	28.38	6.647			
M8 X 1.00	8.30	21/64	8.216	8.406	12.50	16.50	20.50	24.50	28.50	M8 X 1.00	9.299	8.650	8.719	8.742	11.50	15.50	19.50	23.50	27.50	6.917			
M9 X 1.25	9.40	3/8	9.271	9.483	14.63	19.13	23.63	28.13	32.63	M9 X 1.25	10.624	9.812	9.886	9.912	13.38	17.88	22.38	26.88	31.38	7.647			
M9 x 1.00	9.30	23/64	9.216	9.406	13.50	18.00	22.50	27.00	31.50	M9 x 1.00	10.299	9.650	9.719	9.742	12.50	17.00	21.50	26.00	30.50	7.917			
M10 X 1.50	10.40	13/32	10.325	10.561	16.75	21.75	26.75	31.75	36.75	M10 X 1.50	11.949	10.974	11.061	11.089	15.25	20.25	25.25	30.25	35.25	8.376			
M10 X 1.25	10.30	13/32	10.271	10.483	15.63	20.63	25.63	30.63	35.63	M10 X 1.25	11.624	10.812	10.886	10.912	14.38	19.38	24.38	29.38	34.38	8.647			
M10 x 1.00	10.30	13/32	10.216	10.406	14.50	19.50	24.50	29.50	34.50	M10 x 1.00	11.299	10.650	10.724	10.742	13.50	18.50	23.50	28.50	33.50	8.917			
M11 X 1.50	11.40	7/16	11.325	11.561	17.75	23.25	28.75	34.25	39.75	M11 X 1.50	12.949	11.974	12.061	12.089	16.25	21.75	27.25	32.75	38.25	9.376			
M11 X 1.25	11.30	7/16	11.271	11.483	16.63	22.13	27.63	33.13	38.63	M11 X 1.25	12.624	11.812	11.886	11.926	15.38	20.88	26.38	31.88	37.38	9.647			
M11 X 1.00	11.30	7/16	11.216	11.406	15.50	21.00	26.50	32.00	37.50	M11 X 1.00	12.299	11.650	11.724	11.742	14.50	20.00	25.50	31.00	36.50	9.917			
M12 X 1.75	12.50	31/64	12.379	12.644	19.88	25.88	31.88	37.88	43.88	M12 X 1.75	14.273	13.137	13.236	13.271	18.13	24.13	30.13	36.13	42.13	10.106			
M12 X 1.50	12.40	31/64	12.325	12.561	18.75	24.75	30.75	36.75	42.75	M12 X 1.50	13.949	12.974	13.067	13.099	17.25	23.25	29.25	35.25	41.25	10.376			
M12 X 1.25	12.30	31/64	12.271	12.483	17.63	23.63	29.63	35.63	41.63	M12 X 1.25	13.624	12.812	12.898	12.926	16.38	22.38	28.38	34.38	40.38	10.647			
M12 X 1.00	12.30	31/64	12.216	12.406	16.50	22.50	28.50	34.50	40.50	M12 X 1.00	13.299	12.649	12.724	12.749	15.50	21.50	27.50	33.50	39.50	10.917			
M13 X 1.75	13.50	33/64	13.379	13.644	20.88	27.38	33.88	40.38	46.88	M13 X 1.75	15.273	14.137	14.236	14.271	19.13	25.63	32.13	38.63	45.13	11.106			
M13 X 1.50	13.20	33/64	13.325	13.561	19.75	26.25	32.75	39.25	45.75	M13 X 1.50	14.949	13.974	14.067	14.099	18.25	24.75	31.25	37.75	44.25	11.376			
M13 X 1.25	13.20	33/64	13.271	13.483	18.63	25.13	31.63	38.13	44.63	M13 X 1.25	14.624	13.812	13.898	13.926	17.38	23.88	30.38	36.88	43.38	11.647			
M14 X 2.00	14.50	37/64	14.433	14.733	23.00	30.00	37.00	44.00	51.00	M14 X 2.00	16.598	15.299	15.406	15.444	21.00	28.00	35.00	42.00	49.00	11.835			
M14 X 1.50	14.40	9/16	14.325	14.561	20.75	27.75	34.75	41.75	48.75	M14 X 1.50	15.949	14.974	15.067	15.099	19.25	26.25	33.25	40.25	47.25	12.376			
M14 X 1.25	14.30	9/16	14.271	14.483	19.63	26.63	33.63	40.63	47.63	M14 X 1.25	15.624	14.812	14.898	14.926	18.38	25.38	32.38	39.38	46.38	12.674			
M14 X 1.00	14.30	9/16	14.216	14.406	18.50	25.50	32.50	39.50	46.50	M14 X 1.00	15.299	14.649	14.724	14.749	17.50	24.50	31.50	38.50	45.50	12.917			
M15 X 2.00	15.50	39/64	15.433	15.733	24.00	31.50	39.00	46.50	54.00	M15 X 2.00	17.598	16.299	16.406	16.444	22.00	29.50	37.00	44.50	52.00	12.835			
M15 X 1.50	15.30	39/64	15.325	15.561	21.75	29.25	36.75	44.25	51.75	M15 X 1.50	16.949	15.974	16.067	16.099	20.25	27.75	35.25	42.75	50.25	13.376			
M16 X 2.00	16.50	21/32	16.433	16.733	25.00	33.00	41.00	49.00	57.00	M16 X 2.00	18.598	17.299	17.406	17.444	23.00	31.00	39.00	47.00	55.00	13.835			
M16 X 1.50	16.50	21/32	16.325	16.561	22.75	30.75	38.75	46.75	54.75	M16 X 1.50	17.949	16.974	17.067	17.099	21.25	29.25	37.25	45.25	53.25	14.376			
M18 X 2.50	18.80	47/64	18.541	18.896	29.25	38.25	47.25	56.25	65.25	M18 X 2.50	21.248	19.624	19.738	19.778	26.75	35.75	44.75	53.75	62.75	15.294			
M18 X 2.00	18.50	23/32	18.433	18.733	27.00	36.00	45.00	54.00	63.00	M18 X 2.00	20.598	19.299	19.406	19.444	25.00	34.00	43.00	52.00	61.00	15.835			
M18 X 1.50	18.50	23/32	18.325	18.561	24.75	33.75	42.75	51.75	60.75	M18 X 1.50	19.949	18.974	19.067	19.099	23.25	32.25	41.25	50.25	59.25	16.376			
M20 X 2.50	20.80	13/16	20.541	20.896	31.25	41.25	51.25	61.25	71.25	M20 X 2.50	23.248	21.624	21.738	21.778	28.75	38.75	48.75	58.75	68.75	17.294			
M20 X 2.00	20.50	13/16	20.433	20.733	29.00	39.00	49.00	59.00	69.00	M20 X 2.00	22.598	21.299	21.406	21.444	27.00	37.00	47.00	57.00	67.00	17.835			
M20 X 1.50	20.50	13/16	20.325	20.561	26.75	36.75	46.75	56.75	66.75	M20 X 1.50	21.949	20.974	21.067	21.099	25.25	35.25	45.25	55.25	65.25	18.376			
M22 X 2.50	22.80	57/64	22.541	22.896	33.25	44.25	55.25	66.25	77.25	M22 X 2.50	25.248	23.624	23.738	23.778	30.75	41.75	52.75	63.75	74.75	19.294			
M22 X 2.00	22.50	57/64	22.433	22.733	31.00	42.00	53.00	64.00	75.00	M22 X 2.00	24.598	23.299	23.406	23.444	29.00	40.00	51.00	62.00	73.00	19.835			
M22 X 1.50	22.20	57/64	22.325	22.561	28.75	39.75	50.75	61.75	72.75	M22 X 1.50	23.949	22.974	23.067	23.099	27.25	38.25	49.25	60.25	71.25	20.376			
M24 X 3.00	25.00	31/32	24.650	25.050	37.50	49.50	61.50	73.50	85.50	M24 X 3.00	27.897	25.948	26.093	26.135	34.50	46.50	58.50	70.50	82.50	20.752			
M24 X 2.00	24.50	31/32	24.433	24.733	33.00	45.00	57.00	69.00	81.00	M24 X 2.00	26.598	25.299	25.414	25.454	31.00	43.00	55.00	67.00	79.00	21.835			
M24 X 1.50	24.50	31/32	24.325	24.561	30.75	42.75	54.75	66.75	78.75	M24 X 1.50	25.949	24.975	25.044	25.135	29.25	41.25	53.25	65.25	77.25	22.376			
M26 X 1.50	26.50	1.1/32	26.325	26.561	32.75	45.75	58.75	71.75	84.75	M26 X 1.50	27.949	26.975	27.044	27.135	31.25	44.25	57.25	70.25	83.25	24.376			
M27 X 3.00	28.00	1.3/32	27.650	28.050																			

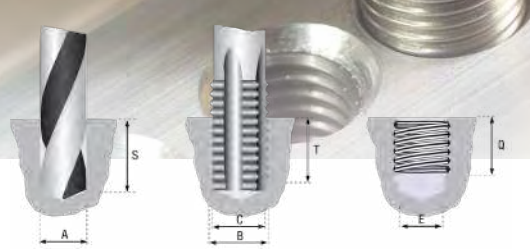

Nominal Thread Size	INSERT SPECIFICATIONS																Nominal Thread Size	
	Q Nominal Length – installed					Free Coil Diameter		Number of Free Coils ± 1/4 coil counted 90° from Tang										
	1D	1.5D	2D	2.5D	3D	Min	Max	1D		1.5D		2D		2.5D		3D		
	mm	mm	mm	mm	mm	mm	mm	Min	Max	Min	Max	Min	Max	Min	Max	Min		Max
METRIC																	METRIC	
M2 X 0.40	2.00	3.00	4.00	5.00	6.00	2.49	2.70	3.00	3.30	5.20	5.70	7.40	8.10	9.60	10.50	11.80	13.00	M2 X 0.40
M2.2 X 0.45	2.20	3.30	4.40	5.50	6.60	2.76	3.00	2.90	3.20	5.00	5.50	7.10	7.90	9.30	10.30	11.40	12.60	M2.2 X 0.45
M2.5 X 0.45	2.50	3.75	5.00	6.25	7.50	3.05	3.70	3.10	3.80	5.20	6.50	7.40	9.20	9.50	11.90	11.70	14.60	M2.5 X 0.45
M3 X 0.50	3.00	4.50	6.00	7.50	9.00	3.61	4.35	3.40	4.30	5.80	7.20	8.20	10.10	10.50	13.10	12.90	16.00	M3 X 0.50
M3.5 X 0.60	3.50	5.25	7.00	8.75	10.50	4.24	4.95	3.40	4.10	5.80	7.00	8.20	9.80	10.50	12.60	12.90	15.50	M3.5 X 0.60
M4 x 0.70	4.00	6.00	8.00	10.00	12.00	4.86	5.60	3.40	4.00	5.70	6.80	8.10	9.60	10.50	12.30	12.80	15.10	M4 x 0.70
M5 X 0.80	5.00	7.50	10.00	12.50	15.00	5.98	6.80	3.90	4.50	6.50	7.60	9.20	10.60	11.80	13.70	14.40	16.70	M5 X 0.80
M6 X 1.00	6.00	9.00	12.00	15.00	18.00	7.23	7.95	3.80	4.30	6.40	7.20	9.10	10.10	11.70	13.10	14.30	16.00	M6 X 1.00
M7 X 1.00	7.00	10.50	14.00	17.50	21.00	8.22	9.20	4.60	5.30	7.70	8.70	10.70	12.10	13.70	15.60	16.70	19.00	M7 X 1.00
M8 X 1.25	8.00	12.00	16.00	20.00	24.00	9.53	10.35	4.20	4.70	7.10	7.80	9.90	10.90	12.80	14.10	15.60	17.20	M8 X 1.25
M8 X 1.00	8.00	12.00	16.00	20.00	24.00	9.39	10.25	5.60	6.10	9.10	10.00	12.50	13.80	16.00	17.70	19.50	21.50	M8 X 1.00
M9 X 1.25	9.00	13.50	18.00	22.50	27.00	10.52	11.16	5.10	5.50	8.40	9.00	11.70	12.50	15.00	16.10	18.30	19.60	M9 X 1.25
M9 x 1.00	9.00	13.50	18.00	22.50	27.00	10.40	11.23	6.50	7.10	10.50	11.50	14.50	15.80	18.50	20.20	22.50	24.50	M9 x 1.00
M10 X 1.50	10.00	15.00	20.00	25.00	30.00	11.83	12.50	4.60	4.90	7.70	8.20	10.80	11.50	13.80	14.70	16.90	18.00	M10 X 1.50
M10 X 1.25	10.00	15.00	20.00	25.00	30.00	11.74	12.65	5.60	6.10	9.20	10.00	12.70	13.80	16.30	17.70	19.80	21.50	M10 X 1.25
M10 x 1.00	10.00	15.00	20.00	25.00	30.00	11.41	12.50	7.30	8.10	11.70	12.90	16.10	17.80	20.50	22.60	24.90	27.50	M10 x 1.00
M11 X 1.50	11.00	16.50	22.00	27.50	33.00	12.82	13.59	5.20	5.60	8.60	9.20	12.00	12.80	15.40	16.40	18.70	20.00	M11 X 1.50
M11 X 1.25	11.00	16.50	22.00	27.50	33.00	12.75	13.76	6.40	6.90	10.30	11.20	14.20	15.40	18.10	19.70	22.00	23.90	M11 X 1.25
M11 X 1.00	11.00	16.50	22.00	27.50	33.00	12.42	13.41	8.40	9.10	13.30	14.40	18.20	19.80	23.10	25.10	28.00	30.40	M11 X 1.00
M12 X 1.75	12.00	18.00	24.00	30.00	36.00	14.13	15.00	4.80	5.10	7.90	8.50	11.10	11.90	14.20	15.20	17.30	18.60	M12 X 1.75
M12 X 1.50	12.00	18.00	24.00	30.00	36.00	14.09	15.20	5.60	6.10	9.20	10.00	12.70	13.80	16.20	17.70	19.80	21.50	M12 X 1.50
M12 X 1.25	12.00	18.00	24.00	30.00	36.00	13.76	15.00	7.00	7.70	11.20	12.40	15.50	17.00	19.70	21.60	23.90	26.30	M12 X 1.25
M12 X 1.00	12.00	18.00	24.00	30.00	36.00	13.43	14.49	9.30	10.10	14.70	15.90	20.00	21.70	25.40	27.60	30.80	33.40	M12 X 1.00
M13 X 1.75	13.00	19.50	26.00	32.50	39.00	15.12	16.04	5.30	5.70	8.70	9.40	12.20	13.00	15.60	16.70	19.00	20.30	M13 X 1.75
M13 X 1.50	13.00	19.50	26.00	32.50	39.00	15.10	16.29	6.20	6.80	10.10	11.00	13.90	15.20	17.80	19.30	21.60	23.50	M13 X 1.50
M13 X 1.25	13.00	19.50	26.00	32.50	39.00	14.77	15.94	7.80	8.50	12.50	13.50	17.10	18.60	21.70	23.60	26.40	28.70	M13 X 1.25
M14 X 2.00	14.00	21.00	28.00	35.00	42.00	16.43	17.35	5.00	5.30	8.20	8.70	11.40	12.10	14.60	15.60	17.90	19.00	M14 X 2.00
M14 X 1.50	14.00	21.00	28.00	35.00	42.00	16.11	17.25	6.90	7.50	11.10	12.00	15.30	16.50	19.40	21.00	23.60	25.50	M14 X 1.50
M14 X 1.25	14.00	21.00	28.00	35.00	42.00	15.78	17.03	8.60	9.30	13.60	14.70	18.60	20.20	23.60	25.60	28.60	31.00	M14 X 1.25
M14 X 1.00	14.00	21.00	28.00	35.00	42.00	15.45	16.68	11.10	12.10	17.40	18.90	23.70	25.70	30.00	32.50	36.20	39.30	M14 X 1.00
M15 X 2.00	15.00	22.50	30.00	37.50	45.00	17.42	18.48	5.40	5.80	8.80	9.50	12.30	13.10	15.70	16.80	19.20	20.50	M15 X 2.00
M15 X 1.50	15.00	22.50	30.00	37.50	45.00	17.12	18.47	7.50	8.10	11.90	12.90	16.40	17.80	20.80	22.60	25.30	27.50	M15 X 1.50
M16 X 2.00	16.00	24.00	32.00	40.00	48.00	18.41	19.60	5.90	6.30	9.50	10.20	13.20	14.20	16.90	18.10	20.50	22.00	M16 X 2.00
M16 X 1.50	16.00	24.00	32.00	40.00	48.00	18.13	19.60	8.00	8.80	12.80	13.90	17.50	19.10	22.30	24.30	27.00	29.40	M16 X 1.50
M18 X 2.50	18.00	27.00	36.00	45.00	54.00	21.04	22.00	5.20	5.50	8.60	9.00	11.90	12.50	15.30	16.10	18.60	19.60	M18 X 2.50
M18 X 2.00	18.00	27.00	36.00	45.00	54.00	20.80	21.85	6.70	7.10	10.90	11.50	15.00	15.80	19.10	20.20	23.20	24.50	M18 X 2.00
M18 X 1.50	18.00	27.00	36.00	45.00	54.00	20.15	21.75	9.30	10.10	14.60	15.90	20.00	21.70	25.40	27.60	30.70	33.40	M18 X 1.50
M20 X 2.50	20.00	30.00	40.00	50.00	60.00	23.02	24.40	5.90	6.30	9.60	10.20	13.30	14.20	16.90	18.10	20.60	22.00	M20 X 2.50
M20 X 2.00	20.00	30.00	40.00	50.00	60.00	22.82	24.05	7.70	8.10	12.20	12.90	16.80	17.80	21.40	22.60	25.90	27.50	M20 X 2.00
M20 X 1.50	20.00	30.00	40.00	50.00	60.00	22.17	24.00	10.50	11.40	16.40	17.90	22.40	24.40	28.30	30.90	34.30	37.40	M20 X 1.50
M22 X 2.50	22.00	33.00	44.00	55.00	66.00	25.00	26.90	6.50	7.10	10.50	11.40	14.50	15.80	18.50	20.10	22.50	24.50	M22 X 2.50
M22 X 2.00	22.00	33.00	44.00	55.00	66.00	24.84	26.50	8.50	9.10	13.40	14.40	18.40	19.80	23.40	25.10	28.40	30.40	M22 X 2.00
M22 X 1.50	22.00	33.00	44.00	55.00	66.00	24.19	26.45	11.60	12.70	18.10	19.90	24.60	27.00	31.10	34.20	37.60	41.30	M22 X 1.50
M24 X 3.00	24.00	36.00	48.00	60.00	72.00	27.82	29.00	5.90	6.30	9.70	10.20	13.40	14.20	17.10	18.10	20.90	22.00	M24 X 3.00
M24 X 2.00	24.00	36.00	48.00	60.00	72.00	26.86	29.10	9.20	10.10	14.60	15.90	19.90	21.70	25.30	27.60	30.60	33.40	M24 X 2.00
M24 X 1.50	24.00	36.00	48.00	60.00	72.00	26.21	28.28	12.90	14.00	20.10	21.80	27.30	29.70	34.50	37.50	41.70	45.30	M24 X 1.50
M26 X 1.50	26.00	39.00	52.00	65.00	78.00	28.23	30.46	14.20	15.40	22.00	23.80	29.80	32.30	37.60	40.80	45.40	49.20	M26 X 1.50
M27 X 3.00	27.00	40.50	54.00	67.50	81.00	30.59	32.40	6.80	7.30	11.00	11.70	15.20	16.20	19.30	20.60	23.50	25.10	M27 X 3.00
M27 X 2.00	27.00	40.50	54.00	67.50	81.00	29.89	32.30	10.60	11.60	16.70	18.10	22.70	24.70	28.80	31.30	34.80	37.90	M27 X 2.00
M30 X 3.50	30.00	45.00	60.00	75.00	90.00	34.20	35.81	6.50	6.90	10.50	11.10	14.50	15.30	18.60	19.50	22.60	23.80	M30 X 3.50
M30 X 3.00	30.00	45.00	60.00	75.00	90.00	34.24	36.10	7.60	8.10	12.20	12.90	16.80	17.80	21.30	22.60	25.90	27.50	M30 X 3.00
M30 X 2.00	30.00	45.00	60.00	75.00	90.00	32.92	35.70	12.00	13.00	18.70	20.40	25.40	27.70	32.10	35.00	38.80	42.30	M30 X 2.00
M33 X 3.50	33.00	49.50	66.00	82.50	99.00	37.17	38.80	7.40	7.70	11.80	12.40	16.20	17.00	20.70	21.70	25.10	26.40	M33 X 3.50
M33 X 3.00	33.00	49.50	66.00	82.50														



Nominal Thread Size	DRILLED HOLE DIMENSIONS									Nominal Thread Size	TAPPED HOLE DIMENSIONS									E Fitted Minor Dia.	
	Drill				S Min. Drilling Depth Inter/Plug						B Major	C Pitch Diameter				T Minimum Tapping Depth					
	Size		A Minor Dia.		1D	1.5D	2D	2.5D	3D			Min	2B Max	1B Max	1D	1.5D	2D	2.5D	3D		
mm	inch	inch	inch	inch	inch	inch	inch	inch	inch	inch	inch	inch	inch	inch	inch	inch	inch				
UNC										UNC											
2 X 56	2.40	#41	0.090	0.094	0.166	0.209	0.252	0.295	0.338	2 X 56	0.109	0.098	0.099	0.100	0.148	0.191	0.234	0.277	0.320	0.0667	
3 X 48	2.70	#36	0.104	0.108	0.193	0.242	0.292	0.341	0.391	3 X 48	0.126	0.113	0.114	0.115	0.172	0.221	0.271	0.320	0.370	0.0764	
4 X 40	3.00	#31	0.117	0.122	0.224	0.280	0.336	0.392	0.448	4 X 40	0.145	0.128	0.130	0.131	0.199	0.255	0.311	0.367	0.423	0.0849	
5 X 40	3.40	#29	0.130	0.135	0.237	0.300	0.362	0.425	0.487	5 X 40	0.158	0.141	0.143	0.144	0.212	0.275	0.337	0.400	0.462	0.0979	
6 X 32	3.70	#25	0.145	0.150	0.279	0.348	0.417	0.486	0.555	6 X 32	0.179	0.158	0.160	0.161	0.247	0.316	0.385	0.454	0.523	0.1040	
8 X 32	4.40	11/64	0.171	0.176	0.305	0.387	0.469	0.551	0.633	8 X 32	0.205	0.184	0.186	0.187	0.273	0.355	0.437	0.519	0.601	0.1300	
10 X 24	5.10	13/64	0.199	0.205	0.377	0.472	0.567	0.662	0.757	10 X 24	0.244	0.217	0.219	0.220	0.336	0.431	0.526	0.621	0.716	0.1450	
12 X 24	5.70	15/64	0.225	0.231	0.403	0.511	0.619	0.727	0.835	12 X 24	0.270	0.243	0.245	0.247	0.362	0.470	0.578	0.686	0.794	0.1710	
1/4 X 20	6.70	17/64	0.261	0.270	0.475	0.600	0.725	0.850	0.975	1/4 X 20	0.315	0.283	0.285	0.286	0.425	0.550	0.675	0.800	0.925	0.1959	
5/16 X 18	8.30	21/64	0.325	0.334	0.562	0.718	0.875	1.031	1.187	5/16 X 18	0.385	0.349	0.352	0.353	0.507	0.663	0.819	0.975	1.132	0.2524	
3/8 X 16	9.90	25/64	0.389	0.399	0.656	0.844	1.031	1.219	1.406	3/8 X 16	0.456	0.416	0.419	0.420	0.594	0.781	0.969	1.156	1.344	0.3073	
7/16 X 14	11.60	29/64	0.453	0.464	0.758	0.977	1.196	1.415	1.633	7/16 X 14	0.530	0.484	0.488	0.489	0.687	0.906	1.125	1.344	1.562	0.3602	
1/2 X 13	13.00	33/64	0.517	0.528	0.846	1.096	1.346	1.596	1.846	1/2 X 13	0.600	0.550	0.554	0.555	0.769	1.019	1.269	1.519	1.769	0.4167	
9/16 X 12	15.00	19/32	0.581	0.592	0.937	1.219	1.500	1.781	2.062	9/16 X 12	0.671	0.617	0.621	0.623	0.854	1.135	1.417	1.698	1.979	0.4723	
5/8 X 11	16.50	21/32	0.645	0.657	1.034	1.347	1.659	1.972	2.284	5/8 X 11	0.743	0.684	0.689	0.690	0.943	1.256	1.568	1.881	2.193	0.5266	
3/4 X 10	19.80	25/32	0.772	0.784	1.200	1.575	1.950	2.325	2.700	3/4 X 10	0.880	0.815	0.820	0.822	1.100	1.475	1.850	2.225	2.600	0.6417	
7/8 X 9	23.00	29/32	0.899	0.912	1.375	1.812	2.250	2.687	3.125	7/8 X 9	1.019	0.947	0.952	0.954	1.264	1.701	2.139	2.576	3.014	0.7547	
1 X 8	26.20	1.1/32	1.027	1.042	1.562	2.062	2.562	3.062	3.562	1 X 8	1.162	1.081	1.087	1.089	1.437	1.937	2.437	2.937	3.437	0.8647	
1-1/8 X 7	29.50	1.5/32	1.156	1.171	1.768	2.330	2.893	3.455	4.018	1-1/8 X 7	1.311	1.218	1.224	1.226	1.625	2.187	2.750	3.312	3.875	0.9704	
1-1/4 X 7	32.50	1.9/32	1.281	1.296	1.893	2.518	3.143	3.768	4.393	1-1/4 X 7	1.436	1.343	1.349	1.351	1.750	2.375	3.000	3.625	4.250	1.0954	
1-3/8 X 6	36.00	1.13/32	1.411	1.431	2.125	2.812	3.500	4.187	4.875	1-3/8 X 6	1.591	1.483	1.490	1.493	1.958	2.646	3.333	4.021	4.708	1.1946	
1-1/2 X 6	39.50	1.35/64	1.536	1.556	2.250	3.000	3.750	4.500	5.250	1-1/2 X 6	1.716	1.608	1.615	1.618	2.083	2.833	3.583	4.333	5.083	1.3196	
UNF										UNF											
2 X 64	2.30	3/32	0.089	0.093	0.156	0.199	0.242	0.285	0.328	2 X 64	0.106	0.096	0.097	0.098	0.141	0.184	0.227	0.270	0.313	0.0691	
3 X 56	2.70	#37	0.103	0.107	0.179	0.229	0.278	0.328	0.377	3 X 56	0.122	0.111	0.112	0.113	0.161	0.210	0.260	0.310	0.359	0.0797	
4 X 48	3.00	#31	0.117	0.121	0.206	0.262	0.318	0.374	0.430	4 X 48	0.139	0.126	0.127	0.128	0.185	0.241	0.297	0.353	0.409	0.0894	
5 X 44	3.40	#30	0.130	0.134	0.227	0.290	0.352	0.414	0.477	5 X 44	0.155	0.140	0.141	0.142	0.204	0.267	0.329	0.391	0.454	0.1004	
6 X 40	3.70	#26	0.143	0.148	0.250	0.319	0.388	0.457	0.526	6 X 40	0.171	0.154	0.156	0.157	0.225	0.294	0.363	0.432	0.501	0.111	
8 X 36	4.40	11/64	0.170	0.175	0.289	0.371	0.453	0.535	0.617	8 X 36	0.200	0.182	0.184	0.185	0.261	0.343	0.425	0.507	0.589	0.134	
10 X 32	5.10	13/64	0.197	0.202	0.331	0.426	0.521	0.616	0.711	10 X 32	0.231	0.210	0.212	0.213	0.299	0.394	0.489	0.584	0.679	0.156	
1/4 X 28	6.60	17/64	0.258	0.265	0.411	0.536	0.661	0.786	0.911	1/4 X 28	0.296	0.273	0.275	0.277	0.375	0.500	0.625	0.750	0.875	0.2113	
5/16 X 24	8.20	21/64	0.322	0.329	0.500	0.656	0.812	0.969	1.125	5/16 X 24	0.367	0.340	0.342	0.343	0.458	0.614	0.771	0.927	1.083	0.2674	
3/8 X 24	9.80	25/64	0.384	0.391	0.562	0.750	0.937	1.124	1.312	3/8 X 24	0.429	0.402	0.405	0.406	0.521	0.708	0.896	1.083	1.271	0.3299	
7/16 X 20	11.50	29/64	0.448	0.456	0.662	0.881	1.100	1.319	1.537	7/16 X 20	0.503	0.470	0.473	0.474	0.612	0.831	1.050	1.269	1.487	0.3834	
1/2 X 20	13.00	33/64	0.511	0.518	0.725	0.975	1.225	1.475	1.725	1/2 X 20	0.565	0.533	0.536	0.537	0.675	0.925	1.175	1.425	1.675	0.4459	
9/16 X 18	14.70	37/64	0.575	0.582	0.811	1.093	1.374	1.655	1.936	9/16 X 18	0.635	0.599	0.602	0.604	0.756	1.038	1.319	1.600	1.881	0.5024	
5/8 X 18	16.30	41/64	0.637	0.645	0.874	1.187	1.500	1.812	2.124	5/8 X 18	0.697	0.661	0.665	0.666	0.819	1.132	1.444	1.757	2.069	0.5649	
3/4 X 16	19.50	49/64	0.764	0.772	1.031	1.406	1.781	2.156	2.531	3/4 X 16	0.831	0.791	0.795	0.796	0.969	1.344	1.719	2.094	2.469	0.6823	
7/8 X 14	22.50	57/64	0.891	0.899	1.196	1.634	2.071	2.509	2.946	7/8 X 14	0.968	0.921	0.926	0.927	1.125	1.562	2.000	2.437	2.875	0.7977	
1 X 12	26.00	1.1/64	1.018	1.028	1.375	1.875	2.375	2.875	3.375	1 X 12	1.108	1.054	1.059	1.061	1.292	1.792	2.292	2.792	3.292	0.9098	
1 X 14	26.00	1.1/64	1.016	1.024	1.320	1.820	2.320	2.820	3.320	1 X 14	1.093	1.046	1.051	1.053	1.250	1.750	2.250	2.750	3.250	0.9277	
1-1/8 X 12	29.50	1.5/32	1.143	1.154	1.500	2.062	2.625	3.187	3.750	1-1/8 X 12	1.233	1.179	1.184	1.186	1.417	1.979	2.542	3.104	3.667	1.0348	
1-1/4 X 12	32.50	1.9/32	1.268	1.279	1.625	2.250	2.875	3.500	4.125	1-1/4 X 12	1.358	1.304	1.309	1.311	1.542	2.167	2.792	3.417	4.042	1.1598	
1-3/8 X 12	35.50	1.13/32	1.393	1.404	1.750	2.438	3.125	3.813	4.500	1-3/8 X 12	1.483	1.429	1.434	1.436	1.667	2.354	3.042	3.729	4.417	1.2848	
1-1/2 X 12	38.50	1.17/32	1.518	1.529	1.875	2.625	3.375	4.125	4.875	1-1/2 X 12	1.608	1.554	1.560	1.562	1.792	2.542	3.292	4.042	4.792	1.4098	

Optimum thread performance with Wire Thread Inserts is achieved when the inserts are installed 1/2 to 1 pitch below the surface of the tapped hole. This means that the actual length of an installed insert is equal to dimension Q less 1/2 to 1 pitch. Dimensions S and T allow for tap end clearance of intermediate taps. When using Bottoming and Spiral Flute Taps these dimensions may be reduced by an amount equal to 2 thread pitches. Any countersink depths must be added to these dimensions.

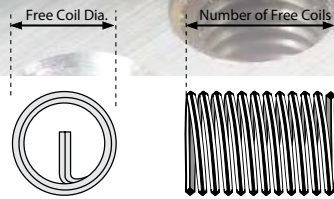

Nominal Thread Size	INSERT SPECIFICATIONS																Nominal Thread Size	
	Q Nominal Length – installed					Free Coil		Number of Free Coils ± 1/4 coil counted 90° from Tang										
	1D	1.5D	2D	2.5D	3D	Min	Max	1D		1.5D		2D		2.5D		3D		
	inch	inch	inch	inch	inch	inch	inch	Min	Max	Min	Max	Min	Max	Min	Max	Min		Max
UNC																	UNC	
2 X 56	0.086	0.129	0.172	0.215	0.258	0.11	0.12	2.80	3.10	4.80	5.40	6.90	7.80	9.00	10.10	11.10	12.50	2 X 56
3 X 48	0.099	0.148	0.198	0.247	0.297	0.12	0.14	2.80	3.20	4.90	5.50	7.00	7.90	9.00	10.30	11.20	12.70	3 X 48
4 X 40	0.112	0.168	0.224	0.280	0.336	0.14	0.16	2.40	2.80	4.30	4.90	6.20	7.10	8.10	9.20	10.00	11.40	4 X 40
5 X 40	0.125	0.187	0.250	0.312	0.375	0.16	0.17	2.90	3.30	5.00	5.70	7.20	8.10	9.30	10.50	11.50	13.00	5 X 40
6 X 32	0.138	0.207	0.276	0.345	0.414	0.18	0.19	2.40	2.70	4.30	4.80	6.20	7.00	8.20	9.10	10.10	11.20	6 X 32
8 X 32	0.164	0.246	0.328	0.410	0.492	0.20	0.22	3.20	3.50	5.50	6.10	7.80	8.60	10.10	11.20	12.40	13.70	8 X 32
10 X 24	0.190	0.285	0.380	0.475	0.570	0.24	0.26	2.60	2.80	4.60	5.00	6.70	7.20	8.70	9.40	10.70	11.60	10 X 24
12 X 24	0.216	0.324	0.432	0.540	0.648	0.27	0.28	3.20	3.50	5.60	6.00	7.90	8.50	10.30	11.00	12.60	13.50	12 X 24
1/4 X 20	0.250	0.375	0.500	0.625	0.750	0.31	0.33	3.10	3.30	5.30	5.70	7.60	8.10	9.90	10.50	12.10	13.00	1/4 X 20
5/16 X 18	0.312	0.469	0.625	0.781	0.937	0.38	0.40	3.70	3.90	6.30	6.70	8.90	9.50	11.50	12.20	14.10	15.00	5/16 X 18
3/8 X 16	0.375	0.562	0.750	0.937	1.125	0.45	0.47	4.10	4.30	6.80	7.20	9.60	10.10	12.40	13.10	15.20	16.00	3/8 X 16
7/16 X 14	0.437	0.656	0.875	1.094	1.312	0.52	0.55	4.10	4.40	7.00	7.40	9.80	10.40	12.60	13.40	15.50	16.30	7/16 X 14
1/2 X 13	0.500	0.750	1.000	1.250	1.500	0.59	0.62	4.50	4.80	7.50	8.00	10.60	11.10	13.60	14.30	16.60	17.50	1/2 X 13
9/16 X 12	0.562	0.844	1.125	1.406	1.687	0.66	0.69	4.80	5.00	7.90	8.40	11.10	11.70	14.20	15.00	17.40	18.30	9/16 X 12
5/8 X 11	0.625	0.937	1.250	1.562	1.875	0.74	0.77	4.90	5.10	8.10	8.50	11.30	11.90	14.50	15.20	17.70	18.60	5/8 X 11
3/4 X 10	0.750	1.125	1.500	1.875	2.250	0.87	0.91	5.50	5.80	9.00	9.50	12.60	13.10	16.10	16.80	19.60	20.50	3/4 X 10
7/8 X 9	0.875	1.312	1.750	2.187	2.625	1.01	1.05	5.90	6.20	9.60	10.00	13.30	13.90	17.00	17.80	20.70	21.70	7/8 X 9
1 X 8	1.000	1.500	2.000	2.500	3.000	1.15	1.20	6.00	6.30	9.80	10.20	13.60	14.20	17.30	18.10	21.10	22.00	1 X 8
1-1/8 X 7	1.125	1.687	2.250	2.812	3.375	1.30	1.36	5.90	6.20	9.60	10.10	13.30	14.00	17.00	17.90	20.70	21.80	1-1/8 X 7
1-1/4 X 7	1.250	1.875	2.500	3.125	3.750	1.42	1.48	6.70	7.10	10.90	11.40	15.00	15.80	19.20	20.10	23.30	24.40	1-1/4 X 7
1-3/8 X 6	1.375	2.062	2.750	3.437	4.125	1.58	1.64	6.20	6.50	10.10	10.60	14.00	14.60	17.80	18.70	21.70	22.70	1-3/8 X 6
1-1/2 X 6	1.500	2.250	3.000	3.750	4.500	1.70	1.77	6.90	7.30	11.20	11.70	15.40	16.10	19.60	20.60	23.90	25.00	1-1/2 X 6
UNF																	UNF	
2 X 64	0.086	0.129	0.172	0.215	0.258	0.11	0.12	3.40	3.70	5.80	6.30	8.20	8.90	10.50	11.60	12.90	14.20	2 X 64
3 X 56	0.099	0.148	0.198	0.247	0.297	0.12	0.15	3.10	3.70	5.20	6.40	7.40	9.00	9.60	11.60	11.80	14.30	3 X 56
4 X 48	0.112	0.168	0.224	0.280	0.336	0.14	0.16	3.20	3.70	5.40	6.40	7.60	9.00	9.80	11.60	12.10	14.20	4 X 48
5 X 44	0.125	0.187	0.250	0.312	0.375	0.16	0.17	3.40	3.70	5.80	6.30	8.20	8.90	10.60	11.50	13.00	14.20	5 X 44
6 X 40	0.138	0.207	0.276	0.345	0.414	0.17	0.19	3.20	3.70	5.50	6.30	7.80	9.00	10.10	11.60	12.40	14.20	6 X 40
8 X 36	0.164	0.246	0.328	0.410	0.492	0.20	0.22	3.60	4.10	6.10	6.90	8.60	9.70	11.10	12.50	13.60	15.30	8 X 36
10 X 32	0.190	0.285	0.380	0.475	0.570	0.23	0.26	3.80	4.30	6.40	7.20	9.00	10.10	11.60	13.00	14.20	15.90	10 X 32
1/4 X 28	0.250	0.375	0.500	0.625	0.750	0.30	0.33	4.70	5.20	7.70	8.50	10.80	11.90	13.80	15.20	16.90	18.60	1/4 X 28
5/16 X 24	0.312	0.469	0.625	0.781	0.937	0.37	0.40	5.10	5.60	8.50	9.20	11.70	12.80	15.00	16.40	18.30	20.00	5/16 X 24
3/8 X 24	0.375	0.562	0.750	0.937	1.125	0.43	0.47	6.50	7.10	10.50	11.40	14.50	15.80	18.50	20.10	22.50	24.50	3/8 X 24
7/16 X 20	0.437	0.656	0.875	1.094	1.312	0.51	0.55	6.30	6.90	10.20	11.10	14.00	15.30	17.90	19.50	21.70	23.70	7/16 X 20
1/2 X 20	0.500	0.750	1.000	1.250	1.500	0.57	0.62	7.40	8.10	11.90	12.90	16.30	17.80	20.80	22.60	25.20	27.50	1/2 X 20
9/16 X 18	0.562	0.844	1.125	1.406	1.687	0.64	0.69	7.60	8.30	12.20	13.30	16.80	18.20	21.30	23.10	25.90	28.10	9/16 X 18
5/8 X 18	0.625	0.937	1.250	1.562	1.875	0.70	0.76	8.70	9.40	13.80	14.90	18.90	20.50	24.00	26.00	29.10	31.50	5/8 X 18
3/4 X 16	0.750	1.125	1.500	1.875	2.250	0.84	0.90	9.30	10.10	14.70	15.90	20.10	21.70	25.50	27.60	30.90	33.40	3/4 X 16
7/8 X 14	0.875	1.312	1.750	2.187	2.625	0.98	1.05	9.60	10.30	15.10	16.30	20.60	22.20	26.10	28.20	31.60	34.20	7/8 X 14
1 X 12	1.000	1.500	2.000	2.500	3.000	1.12	1.20	9.40	10.10	14.80	16.00	20.30	21.80	25.70	27.70	31.10	33.50	1 X 12
1 X 14	1.000	1.500	2.000	2.500	3.000	1.10	1.19	11.20	12.10	17.50	18.90	23.80	25.70	30.10	32.50	36.40	39.40	1 X 14
1-1/8 X 12	1.125	1.687	2.250	2.812	3.375	1.25	1.33	10.80	11.60	16.90	18.20	23.00	24.80	29.20	31.40	35.30	38.00	1-1/8 X 12
1-1/4 X 12	1.250	1.875	2.500	3.125	3.750	1.37	1.47	12.20	13.10	19.00	20.40	25.80	27.80	32.70	35.10	39.50	42.50	1-1/4 X 12
1-3/8 X 12	1.375	2.062	2.750	3.437	4.125	1.50	1.61	13.50	14.60	21.00	22.70	28.50	30.80	36.00	38.80	43.50	46.90	1-3/8 X 12
1-1/2 X 12	1.500	2.250	3.000	3.750	4.500	1.62	1.75	14.90	16.10	23.10	24.90	31.30	33.70	39.50	42.60	47.70	51.40	1-1/2 X 12

IMPORTANT
The success of any drilling and tapping operation is dependant upon many factors –type of material being cut, cutting speed, coolant, equipment being used – and it is not possible to give specific drill sizes for each material. Drill sizes shown are recommendations only and PowerCoil would strongly suggest that independent testing be performed for specific and critical applications.

When using wire thread inserts it is important that the drilling and tapping diameters and lengths listed below are adhered to.

The figures outlined in these tables encompass effective free coil tolerances for most globally recognized standards and manufacturers, including those of reduced diameter wire thread inserts. PowerCoil wire thread inserts can be manufactured to different standards upon request. Technical data on these standards can be obtained from our website – www.powercoil.com.au.

PAGE INTENTIONALLY LEFT BLANK



Loksert[®]

Solid
Keylocking

 CROSSROAD[®]
DISTRIBUTOR SOURCE





Kits

Thin Wall

GROUP	PSCI	PSSI
INSERT TYPE	SOLID KEYLOCKING	SOLID KEYLOCKING
INSERT MATERIAL	CARBON STEEL	STAINLESS STEEL
STYLE	THIN WALL	THIN WALL



MC
MF
UNC
UNF

METRIC COARSE

MM	MM	MM X MM	MM	PART #	PART #	#	MM	PART #	PART #	MM
5.00	0.80	8.00 X 1.25	8.00	3620-5.00TWK	3720-5.00TWK	5	6.9	3620-8.00I	3600-190T	8.25*
6.00	1.00	10.00 X 1.25	10.00	3620-6.00TWK	3720-6.00TWK	5	8.8	3621-10.00I	3600-250T	10.25*
8.00	1.25	12.00 X 1.25	12.00	3620-8.00TWK	3720-8.00TWK	5	10.8	3622-12.00I	3600-312T	12.25*
10.00	1.50	14.00 X 1.50	14.00	3620-10.00TWK	3720-10.00TWK	5	12.8	3621-14.00I	3600-375T	14.25*
12.00	1.75	16.00 X 1.50	16.00	3620-12.00TWK	3720-12.00TWK	5	14.75	3621-16.00I	3600-500T	16.25*

METRIC FINE

MM	MM	MM X MM	MM	PART #	PART #	#	MM	PART #	PART #	MM
8.00	1.00	12.00 X 1.25	12.00	3621-8.00TWK	3721-8.00TWK	5	10.8	3622-12.00I	3600-312T	12.25*
10.00	1.25	14.00 X 1.50	14.00	3621-10.00TWK	3721-10.00TWK	5	12.8	3621-14.00I	3600-375T	14.25*
12.00	1.25	16.00 X 1.50	16.00	3621-12.00TWK	3721-12.00TWK	5	14.75	3621-16.00I	3600-500T	16.25*

UNC

INCH	TPI	INCH X TPI	INCH	PART #	PART #	#	INCH	PART #	PART #	INCH
10G	24	5/16 X 18	0.31	3632-10GTWK	3732-10GTWK	5	I	3632-5/16I	3600-190T	0.32*
1/4	20	3/8 X 16	0.37	3632-1/4TWK	3732-1/4TWK	5	Q	3632-3/8I	3600-250T	0.38*
5/16	18	7/16 X 14	0.43	3632-5/16TWK	3732-5/16TWK	5	X	3632-7/16I	3600-312T	0.44*
3/8	16	1/2 X 13	0.50	3632-3/8TWK	3732-3/8TWK	5	29/64	3632-1/2I	3600-375T	0.51*
7/16	14	9/16 X 12	0.56	3632-7/16TWK	3732-7/16TWK	5	33/64	3632-9/16I	3600-375T	0.57*
1/2	13	5/8 X 11	0.62	3632-1/2TWK	3732-1/2TWK	5	37/64	3632-5/8I	3600-500T	0.63*

UNF

INCH	TPI	INCH X TPI	INCH	PART #	PART #	#	INCH	PART #	PART #	INCH
10G	32	5/16 X 18	0.31	3634-10GTWK	3734-10GTWK	5	I	3632-5/16I	3600-190T	0.32*
1/4	28	3/8 X 16	0.37	3634-1/4TWK	3734-1/4TWK	5	Q	3632-3/8I	3600-250T	0.38*
5/16	24	7/16 X 14	0.43	3634-5/16TWK	3734-5/16TWK	5	X	3632-7/16I	3600-312T	0.44*
3/8	24	1/2 X 13	0.50	3634-3/8TWK	3734-3/8TWK	5	29/64	3632-1/2I	3600-375T	0.51*
7/16	20	9/16 X 12	0.56	3634-7/16TWK	3734-7/16TWK	5	33/64	3632-9/16I	3600-375T	0.57*
1/2	20	5/8 X 11	0.62	3634-1/2TWK	3734-1/2TWK	5	37/64	3632-5/8I	3600-500T	0.63*

* Countersink not included in kit.

Loksert
Loksert solid keylocking inserts are an easily installed thread assembly that is ideal for replacing damaged or worn threads in virtually any material – ferrous, non-ferrous and non-metallic. They are constructed from high quality carbon steel or extremely hard wearing stainless steel. One piece Loksert inserts are supplied with the dove-tailed locking keys pre-assembled. The pre-positioned keys automatically position the insert at the correct depth below the surface of the parent material. Lokserts are suitable for repairing and creating threads in a wide range of applications including forgings and castings and are especially suited to situations that experience heavy wear and vibration - such as mining, construction and earthmoving equipment.

GROUP	PSCI	PSSI
INSERT TYPE	SOLID KEYLOCKING	SOLID KEYLOCKING
INSERT MATERIAL	CARBON STEEL	STAINLESS STEEL
STYLE	HEAVY DUTY	HEAVY DUTY



Kits

Heavy Duty

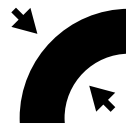

**MC
MF
UNC
UNF**

Loksert Features and Benefits

Solid bushing utilizing locking keys provides positive mechanical lock against rotation.

High strength and reliability provides maximum pullout strength.

Installed using standard drills and taps.

Simple installation - no special skills required.

Suitable for use in a wide range of parent materials.

Impossible to cross thread during installation.

Simple removal process if required.

No tang to break and remove.

Available in metric sizes and inch sizes.

Available in Thinwall and Heavy Duty.

METRIC COARSE

MM	MM	MM X MM	MM	PART #	PART #	#	MM	PART #	PART #	MM
5.00	0.80	10.00 X 1.25	10.00	3620-5.00HDK	3720-5.00HDK	5	8.80	3621-10.00I	3600-190T	5.25*
6.00	1.00	12.00 X 1.25	12.00	3620-6.00HDK	3720-6.00HDK	5	10.80	3622-12.00I	3600-250T	12.25*
8.00	1.25	14.00 X 1.50	14.00	3620-8.00HDK	3720-8.00HDK	5	12.80	3621-14.00I	3600-312T	14.25*
10.00	1.50	16.00 X 1.50	16.00	3620-10.00HDK	3720-10.00HDK	5	14.75	3621-16.00I	3600-375T	16.25*
12.00	1.75	18.00 X 1.50	18.00	3620-12.00HDK	3720-12.00HDK	5	16.75	3622-18.00I	3600-500T	18.25*
16.00	2.00	22.00 X 1.50	22.00	3620-16.00HDK	3720-16.00HDK	5	20.50	3621-22.00I	3600-625T	20.25*

METRIC FINE

MM	MM	MM X MM	MM	PART #	PART #	#	MM	PART #	PART #	MM
8.00	1.00	14.00 X 1.50	14.00	3621-8.00HDK	3721-8.00HDK	5	12.80	3621-14.00I	3600-312T	14.25*
10.00	1.25	16.00 X 1.50	16.00	3621-10.00HDK	3721-10.00HDK	5	14.75	3621-16.00I	3600-375T	16.25*
12.00	1.25	18.00 X 1.50	18.00	3621-12.00HDK	3721-12.00HDK	5	16.75	3622-18.00I	3600-500T	18.25*
16.00	1.50	22.00 X 1.50	22.00	3621-16.00HDK	3721-16.00HDK	5	20.50	3621-22.00I	3600-625T	20.25*

UNC

INCH	TPI	INCH X TPI	INCH	PART #	PART #	#	INCH	PART #	PART #	INCH
10G	24	3/8 X 16	0.31	3632-10GHDK	3732-10GHDK	5	Q	3632-3/8I	3600-190T	0.32*
1/4	20	7/16 X 14	0.37	3632-1/4HDK	3732-1/4HDK	5	X	3632-7/16I	3600-250T	0.38*
5/16	18	1/2 X 13	0.43	3632-5/16HDK	3732-5/16HDK	5	29/64	3632-1/2I	3600-312T	0.44*
3/8	16	9/16 X 12	0.50	3632-3/8HDK	3732-3/8HDK	5	33/64	3632-9/16I	3600-375T	0.51*
7/16	14	5/8 X 11	0.56	3632-7/16HDK	3732-7/16HDK	5	37/64	3632-5/8I	3600-375T	0.57*
1/2	13	3/4 X 16	0.62	3632-1/2HDK	3732-1/2HDK	5	45/64	3632-3/4I	3600-500T	0.63*
9/16	12	3/4 X 16	0.81	3632-9/16HDK	3732-9/16HDK	5	45/64	3632-3/4I	3600-500T	0.82*
5/8	11	7/8 X 14	0.87	3632-5/8HDK	3732-5/8HDK	5	53/64	3632-7/8I	3600-625T	0.88*

UNF

INCH	TPI	INCH X TPI	INCH	PART #	PART #	#	INCH	PART #	PART #	INCH
10G	32	3/8 X 16	0.31	3634-10GHDK	3734-10GHDK	5	Q	3632-3/8I	3600-190T	0.32*
1/4	28	7/16 X 14	0.37	3634-1/4HDK	3734-1/4HDK	5	X	3632-7/16I	3600-250T	0.38*
5/16	24	1/2 X 13	0.43	3634-5/16HDK	3734-5/16HDK	5	29/64	3632-1/2I	3600-312T	0.44*
3/8	24	9/16 X 12	0.50	3634-3/8HDK	3734-3/8HDK	5	33/64	3632-9/16I	3600-375T	0.51*
7/16	20	5/8 X 11	0.56	3634-7/16HDK	3734-7/16HDK	5	37/64	3632-5/8I	3600-375T	0.57*
1/2	20	3/4 X 16	0.62	3634-1/2HDK	3734-1/2HDK	5	45/64	3632-3/4I	3600-500T	0.63*
19/16	18	3/4 X 16	0.81	3634-9/16HDK	3734-9/16HDK	5	45/64	3632-3/4I	3600-500T	0.82*
5/8	18	7/8 X 14	0.87	3634-5/8HDK	3734-5/8HDK	5	53/64	3632-7/8I	3600-625T	0.88*

* Countersink not included in kit.



Retail Pack

Thin Wall

GROUP	PSCI
INSERT TYPE	SOLID KEYLOCKING
INSERT MATERIAL	CARBON STEEL
STYLE	THIN WALL



**MC
MF
UNC
UNF**

METRIC COARSE

MM	MM	MM X MM	MM	#	PART #
5.00	0.80	8.00 X 1.25	8.00	5	3620-5.00TWP
6.00	1.00	10.00 X 1.25	10.00	5	3620-6.00TWP
8.00	1.25	12.00 X 1.25	12.00	5	3620-8.00TWP
10.00	1.50	14.00 X 1.50	14.00	5	3620-10.00TWP
12.00	1.75	16.00 X 1.50	16.00	5	3620-12.00TWP

METRIC FINE

MM	MM	MM X MM	MM	#	PART #
8.00	1.00	12.00 X 1.25	12.00	5	3621-8.00TWP
10.00	1.25	14.00 X 1.50	14.00	5	3621-10.00TWP
12.00	1.25	16.00 X 1.50	16.00	5	3621-12.00TWP

UNC

INCH	TPI	INCH X TPI	INCH	#	PART #
10G	24	5/16 X 18	0.31	5	3632-10GTWP
1/4	20	3/8 X 16	0.37	5	3632-1/4TWP
5/16	18	7/16 X 14	0.43	5	3632-5/16TWP
3/8	16	1/2 X 13	0.50	5	3632-3/8TWP
7/16	14	9/16 X 12	0.56	5	3632-7/16TWP
1/2	13	5/8 X 11	0.62	5	3632-1/2TWP

UNF

INCH	TPI	INCH X TPI	INCH	#	PART #
10G	32	5/16 X 18	0.31	5	3634-10GTWP
1/4	28	3/8 X 16	0.37	5	3634-1/4TWP
5/16	24	7/16 X 14	0.43	5	3634-5/16TWP
3/8	24	1/2 X 13	0.50	5	3634-3/8TWP
7/16	20	9/16 X 12	0.56	5	3634-7/16TWP
1/2	20	5/8 X 11	0.62	5	3634-1/2TWP

Loksert
Loksert solid keylocking inserts are an easily installed thread assembly that is ideal for replacing damaged or worn threads in virtually any material – ferrous, non-ferrous and non-metallic. They are constructed from high quality carbon steel or extremely hard wearing stainless steel. One piece Loksert inserts are supplied with the dove-tailed locking keys pre-assembled. The pre-positioned keys automatically position the insert at the correct depth below the surface of the parent material. Lokserts are suitable for repairing and creating threads in a wide range of applications including forgings and castings and are especially suited to situations that experience heavy wear and vibration - such as mining, construction and earthmoving equipment.

GROUP	PSCI
INSERT TYPE	SOLID KEYLOCKING
INSERT MATERIAL	CARBON STEEL
STYLE	THIN WALL



Loksert Features and Benefits

Solid bushing utilizing locking keys provides positive mechanical lock against rotation.

High strength and reliability provides maximum pullout strength.

Installed using standard drills and taps.

Simple installation - no special skills required.

Suitable for use in a wide range of parent materials.



Impossible to cross thread during installation.

Simple removal process if required.

No tang to break and remove.

Available in metric sizes and inch sizes.

Available in Thinwall and Heavy Duty.

MERCHANDISER				
				
	PART #	#		PART #
LOKSERT HANG SELL MERCHANDISER	3600-D1	2	M6.00 x 1.00	3620-6.00TWP
		2	M8.00 x 1.25	3620-8.00TWP
		1	M10.00 x 1.50	3620-10.00TWP
		1	M12.00 x 1.75	3620-12.00TWP
		1	UNC 1/4 x 20	3632-1/4TWP
		1	UNC 5/16 x 18	3632-5/16TWP
		1	UNC 3/8 x 16	3632-3/8TWP
		1	UNC 1/2 x 13	3632-1/2TWP
		1	UNF1/4 x 28	3634-1/4TWP
		1	UNF 3/8 x 24	3634-3/8TWP
		1	HSS DRILL 8.8mm	3620-8.8
		1	HSS DRILL 10.8mm	3620-10.8
		1	HSS DRILL 12.8mm	3620-12.8
		1	HSS DRILL 14.75mm	3620-14.75
		1	HSS DRILL Q(8.43/0.332)	3632-Q
		1	HSS DRILL X(10.0/0.397)	3632-X
		1	HSS DRILL 29/64	3632-29/64
		1	HSS DRILL 37/64	3632-37/64
		1	TAP INTER 10.00 x 1.25	3621-10.00I
		1	TAP INTER 12.00 x 1.25	3622-12.00I
		1	TAP INTER 14.00 x 1.5	3621-14.00I
		1	TAP INTER 16.00 x 1.5	3621-16.00I
		1	TAP INTER 3/8 x 16	3632-3/8I
		1	TAP INTER 7/16 x 14	3632-7/16I
		1	TAP INTER 1/2 x 13	3632-1/2I
		1	TAP INTER 5/8 x 11	3632-5/8I
		1	UNIVERSAL TOOL	3600-250T
		1	UNIVERSAL TOOL	3600-312T
		1	UNIVERSAL TOOL	3600-375T
		1	UNIVERSAL TOOL	3600-500T



Bulk

Thin Wall



GROUP	PSCI
INSERT TYPE	SOLID KEYLOCKING
INSERT MATERIAL	CARBON STEEL
STYLE	THIN WALL



**MC
MF
UNC
UNF**

Loksert

Loksert solid keylocking inserts are an easily installed thread assembly that is ideal for replacing damaged or worn threads in virtually any material – ferrous, non-ferrous and non-metallic.

They are constructed from high quality carbon steel or extremely hard wearing stainless steel. One piece Loksert inserts are supplied with the dove-tailed locking keys pre-assembled.

The pre-positioned keys automatically position the insert at the correct depth below the surface of the parent material.

Lokserts are suitable for repairing and creating threads in a wide range of applications including forgings and castings and are especially suited to situations that experience heavy wear and vibration - such as mining, construction and earthmoving equipment.

METRIC COARSE – THIN WALL INSERTS					CARBON STEEL	STAINLESS STEEL
MM	MM	MM	MM	MM	PART #	PART #
5.00	0.80	8.00 X 1.25	8.00	6.9	3620-5.00TW	3720-5.00TW
6.00	1.00	10.00 X 1.25	10.00	8.8	3620-6.00TW	3720-6.00TW
8.00	1.25	12.00 X 1.50	12.00	10.8	3620-8.00TW	3720-8.00TW
10.00	1.50	14.00 X 1.50	14.00	12.8	3620-10.00TW	3720-10.00TW
12.00	1.75	16.00 X 1.50	16.00	14.75	3620-12.00TW	3720-12.00TW

METRIC FINE – THIN WALL INSERTS					CARBON STEEL	STAINLESS STEEL
MM	MM	MM	MM	MM	PART #	PART #
8.00	1.00	12.00 X 1.50	12.00	10.8	3621-8.00TW	3721-8.00TW
10.00	1.25	14.00 X 1.50	14.00	12.8	3621-10.00TW	3721-10.00TW
12.00	1.25	16.00 X 1.50	16.00	14.75	3621-12.00TW	3721-12.00TW

UNC – THIN WALL INSERTS					CARBON STEEL	STAINLESS STEEL
INCH	TPI	INCH X TPI	INCH	INCH	PART #	PART #
10G	24	5/16 X 18	0.31	I	3632-10GTW	3732-10GTW
1/4	20	3/8 X 16	0.37	Q	3632-1/4TW	3732-1/4TW
5/16	18	7/16 X 14	0.43	X	3632-5/16TW	3732-5/16TW
3/8	16	1/2 X 13	0.50	29/64	3632-3/8TW	3732-3/8TW
7/16	14	9/16 X 12	0.56	33/64	3632-7/16TW	3732-7/16TW
1/2	13	5/8 X 11	0.62	37/64	3632-1/2TW	3732-1/2TW

UNF – THIN WALL INSERTS					CARBON STEEL	STAINLESS STEEL
INCH	TPI	INCH X TPI	INCH	INCH	PART #	PART #
10G	32	5/16 X 18	0.31	I	3634-10GTW	3734-10GTW
1/4	28	3/8 X 16	0.37	Q	3634-1/4TW	3734-1/4TW
5/16	24	7/16 X 14	0.43	X	3634-5/16TW	3734-5/16TW
3/8	24	1/2 X 13	0.50	29/64	3634-3/8TW	3734-3/8TW
7/16	20	9/16 X 12	0.56	33/64	3634-7/16TW	3734-7/16TW
1/2	20	5/8 X 11	0.62	37/64	3634-1/2TW	3734-1/2TW

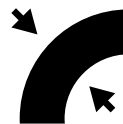
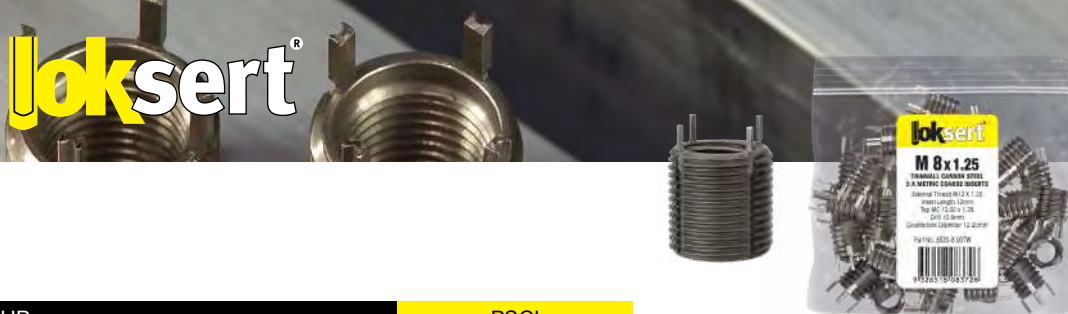

**MC
MF**

GROUP	PSCI
INSERT TYPE	SOLID KEYLOCKING
INSERT MATERIAL	CARBON STEEL
STYLE	HEAVY DUTY

METRIC COARSE – HEAVY DUTY CARBON STEEL BULK INSERTS

MM	MM	MM	MM	MM	PART #
4.00	0.70	8.00 X 1.25	8.00	6.9	3620-4.00HD
5.00	0.80	10.00 X 1.25	10.00	8.8	3620-5.00HD
6.00	1.00	12.00 X 1.25	12.00	10.8	3620-6.00HD
8.00	1.25	14.00 X 1.50	14.00	12.8	3620-8.00HD
10.00	1.50	16.00 X 1.50	16.00	14.75	3620-10.00HD
12.00	1.75	18.00 X 1.50	18.00	16.75	3620-12.00HD
14.00	2.00	20.00 X 1.50	20.00	18.75	3620-14.00HD
16.00	2.00	22.00 X 1.50	22.00	20.5	3620-16.00HD
20.00	2.50	30.00 X 2.00	30.00	28.0	3620-20.00HD
24.00	3.00	33.00 X 2.00	33.00	31.0	3620-24.00HD

METRIC FINE – HEAVY DUTY CARBON STEEL BULK INSERTS

MM	MM	MM	MM	MM	PART #
8.00	1.00	14.00 X 1.5	8.00	12.8	3621-8.00HD
10.00	1.25	16.00 X 1.5	16.00	14.75	3621-10.00HD
12.00	1.25	18.00 X 1.5	18.00	16.75	3621-12.00HD
14.00	1.50	20.00 X 1.5	20.00	18.75	3621-14.00HD
16.00	1.50	22.00 X 1.5	22.00	20.5	3621-16.00HD
18.00	1.50	24.00 X 1.5	24.00	22.5	3621-18.00HD
20.00	1.50	30.00 X 2.0	30.00	28.0	3621-20.00HD
22.00	1.50	32.00 X 2.0	32.00	30.0	3621-22.00HD
24.00	2.00	33.00 X 2.0	33.00	31.0	3621-24.00HD

Loksert

Loksert solid keylocking inserts are an easily installed thread assembly that is ideal for replacing damaged or worn threads in virtually any material – ferrous, non-ferrous and non-metallic.

They are constructed from high quality carbon steel or extremely hard wearing stainless steel. One piece Loksert inserts are supplied with the dove-tailed locking keys pre-assembled. The pre-positioned keys automatically position the insert at the correct depth below the surface of the parent material. Lokserts are suitable for repairing and creating threads in a wide range of applications including forgings and castings and are especially suited to situations that experience heavy wear and vibration - such as mining, construction and earthmoving equipment.

INSTALLATION



1 DRILL
Drill to clear the damaged thread with a standard twist drill. Chamfer the hole with a standard countersink (82° - 100°)

Note: Drill is oversize to accommodate external thread. Check technical charts for correct drill sizes.



2 TAP
Create new thread using a standard tap. Check technical charts for correct tap size.

Note: Use of a suitable lubricant is essential during all tapping procedures.



3 INSERT
Screw the insert into the threaded hole until slightly below the surface of the parent material.



4 DRIVE
Select the correct size installation tool and place over the insert. Drive locking keys down using several hammer taps on end of installation tool.



Bulk

GROUP	PSCI
INSERT TYPE	SOLID KEYLOCKING
INSERT MATERIAL	CARBON STEEL
STYLE	HEAVY DUTY



Heavy Duty



UNC - HEAVY DUTY CARBON STEEL BULK INSERTS

INCH	TPI	INCH X TPI	INCH	INCH	PART #
8G	32	5/16 X 18	0.31	I	3632-8GHD
10G	24	3/8 X 16	0.31	Q	3632-10GHD
1/4	20	7/16 X 14	0.37	X	3632-1/4HD
5/16	18	1/2 X 13	0.43	29/64	3632-5/16HD
3/8	16	9/16 X 12	0.5	33/64	3632-3/8HD
7/16	14	5/8 X 11	0.62	37/64	3632-7/16HD
1/2	13	3/4 X 16	0.62	45/64	3632-1/2HD
9/16	12	3/4 X 16	0.81	45/64	3632-9/16HD
5/8	11	7/8 X 14	0.87	53/64	3632-5/8HD
3/4	10	1-1/8 X 12	1.12	1-1/16	3632-3/4HD
7/8	9	1-1/4 X 12	1.25	1-3/16	3632-7/8HD
1	8	1-3/8 X 12	1.37	1-5/16	3632-1HD
1-1/8	7	1-1/2 X 12	1.62	1-7/16	3632-1.1/8HD
1-1/4	7	1-5/8 X 12	1.81	1-9/16	3632-1.1/4HD
1-1/2	6	1-7/8 X 12	2	1-13/16	3632-1.1/2HD

UNF - HEAVY DUTY CARBON STEEL BULK INSERTS

INCH	TPI	INCH X TPI	INCH	INCH	PART #
10G	32	3/8 X 16	0.31	Q	3634-10GHD
1/4	28	7/16 X 14	0.37	X	3634-1/4HD
5/16	24	1/2 X 13	0.43	29/64	3634-5/16HD
3/8	24	9/16 X 12	0.5	33/64	3634-3/8HD
7/16	20	5/8 X 11	0.62	37/64	3634-7/16HD
1/2	20	3/4 X 16	0.62	45/64	3634-1/2HD
9/16	18	3/4 X 16	0.81	45/64	3634-9/16HD
5/8	18	7/8 X 14	0.87	53/64	3634-5/8HD
3/4	16	1-1/8 X 12	1.12	1-1/16	3634-3/4HD
7/8	14	1-1/4 X 12	1.25	1-3/16	3634-7/8HD
1	12	1-3/8 X 12	1.37	1-5/16	3634-1HD
1	14	1-3/8 X 12	1.37	1-5/16	3635-1HD
1-1/8	12	1-1/2 X 12	1.62	1-7/16	3634-1.1/8HD
1-1/4	12	1-5/8 X 12	1.81	1-9/16	3634-1.1/4HD
1-1/2	12	1-7/8 X 12	2	1-13/16	3634-1.1/2HD



Loksert Features and Benefits

Solid bushing utilizing locking keys provides positive mechanical lock against rotation.

High strength and reliability provides maximum pullout strength.

Installed using standard drills and taps.

Simple installation - no special skills required.

Suitable for use in a wide range of parent materials.

Impossible to cross thread during installation.

Simple removal process if required.

No tang to break and remove.

Available in metric sizes and inch sizes.

Available in Thinwall and Heavy Duty.



REMOVAL

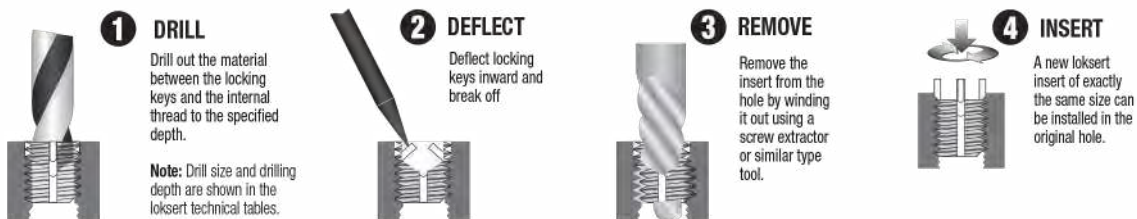

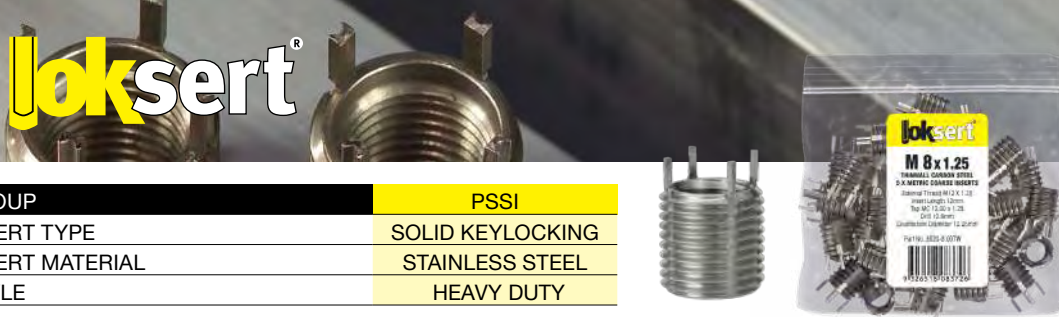

GROUP	PSSI
INSERT TYPE	SOLID KEYLOCKING
INSERT MATERIAL	STAINLESS STEEL
STYLE	HEAVY DUTY



METRIC COARSE – HEAVY DUTY STAINLESS STEEL BULK INSERTS

MM	MM	MM	MM	MM	PART #
4.00	0.70	8.00 X 1.25	8.00	6.9	3720-4.00HD
5.00	0.80	10.00 X 1.25	10.00	8.8	3720-5.00HD
6.00	1.00	12.00 X 1.25	12.00	10.8	3720-6.00HD
8.00	1.25	14.00 X 1.50	14.00	12.8	3720-8.00HD
10.00	1.50	16.00 X 1.50	16.00	14.75	3720-10.00HD
12.00	1.75	18.00 X 1.50	18.00	16.75	3720-12.00HD
14.00	2.00	20.00 X 1.50	20.00	18.75	3720-14.00HD
16.00	2.00	22.00 X 1.50	22.00	20.5	3720-16.00HD
20.00	2.50	30.00 X 2.00	30.00	28	3720-20.00HD
24.00	3.00	33.00 X 2.00	33.00	31	3720-24.00HD



MC MF

Loksert

Loksert solid keylocking inserts are an easily installed thread assembly that is ideal for replacing damaged or worn threads in virtually any material – ferrous, non-ferrous and non-metallic.

They are constructed from high quality carbon steel or extremely hard wearing stainless steel. One piece Loksert inserts are supplied with the dove-tailed locking keys pre-assembled. The pre-positioned keys automatically position the insert at the correct depth below the surface of the parent material. Lokserts are suitable for repairing and creating threads in a wide range of applications including forgings and castings and are especially suited to situations that experience heavy wear and vibration - such as mining, construction and earthmoving equipment.

METRIC FINE – HEAVY DUTY STAINLESS STEEL BULK INSERTS

MM	MM	MM	MM	MM	PART #
8.00	1.00	14.00 X 1.5	8.00	12.8	3721-8.00HD
10.00	1.25	16.00 X 1.5	16.00	14.75	3721-10.00HD
12.00	1.25	18.00 X 1.5	18.00	16.75	3721-12.00HD
14.00	1.50	20.00 X 1.5	20.00	18.75	3721-14.00HD
16.00	1.50	22.00 X 1.5	22.00	20.5	3721-16.00HD
18.00	1.50	24.00 X 1.5	24.00	22.5	3721-18.00HD
20.00	1.50	30.00 X 2.0	30.00	28	3721-20.00HD
22.00	1.50	32.00 X 2.0	32.00	30	3721-22.00HD
24.00	2.00	33.00 X 2.0	33.00	31	3721-24.00HD



Bulk

GROUP	PSSI
INSERT TYPE	SOLID KEYLOCKING
INSERT MATERIAL	STAINLESS STEEL
STYLE	HEAVY DUTY



Loksert Features and Benefits

Solid bushing utilizing locking keys provides positive mechanical lock against rotation.

High strength and reliability provides maximum pullout strength.

Installed using standard drills and taps.

Simple installation - no special skills required.

Suitable for use in a wide range of parent materials.

Impossible to cross thread during installation.

Simple removal process if required.

No tang to break and remove.

Available in metric sizes and inch sizes.

Available in Thinwall and Heavy Duty.

UNC – HEAVY DUTY STAINLESS STEEL BULK INSERTS

INCH	TPI	INCH X TPI	INCH	INCH	PART #
8G	32	5/16 X 18	0.31	I	3732-8GHD
10G	24	3/8 X 16	0.31	Q	3732-10GHD
1/4	20	7/16 X 14	0.37	X	3732-1/4HD
5/16	18	1/2 X 13	0.43	29/64	3732-5/16HD
3/8	16	9/16 X 12	0.5	33/64	3732-3/8HD
7/16	14	5/8 X 11	0.62	37/64	3732-7/16HD
1/2	13	3/4 X 16	0.62	45/64	3732-1/2HD
9/16	12	3/4 X 16	0.81	45/64	3732-9/16HD
5/8	11	7/8 X 14	0.87	53/64	3732-5/8HD
3/4	10	1-1/8 X 12	1.12	1-1/16	3732-3/4HD
7/8	9	1-1/4 X 12	1.25	1-3/16	3732-7/8HD
1	8	1-3/8 X 12	1.37	1-5/16	3732-1HD

UNF – HEAVY DUTY STAINLESS STEEL BULK INSERTS

INCH	TPI	INCH X TPI	INCH	INCH	PART #
10G	32	3/8 X 16	0.31	Q	3734-10GHD
1/4	28	7/16 X 14	0.37	X	3734-1/4HD
5/16	24	1/2 X 13	0.43	29/64	3734-5/16HD
3/8	24	9/16 X 12	0.5	33/64	3734-3/8HD
7/16	20	5/8 X 11	0.62	37/64	3734-7/16HD
1/2	20	3/4 X 16	0.62	45/64	3734-1/2HD
9/16	18	3/4 X 16	0.81	45/64	3734-9/16HD
5/8	18	7/8 X 14	0.87	53/64	3734-5/8HD
3/4	16	1-1/8 X 12	1.12	1-1/16	3734-3/4HD
7/8	14	1-1/4 X 12	1.25	1-3/16	3734-7/8HD
1	12	1-3/8 X 12	1.37	1-5/16	3734-1HD

GROUP	PSIT
INSERT TYPE	SOLID KEYLOCKING
INSERT MATERIAL	CARBON & STAINLESS

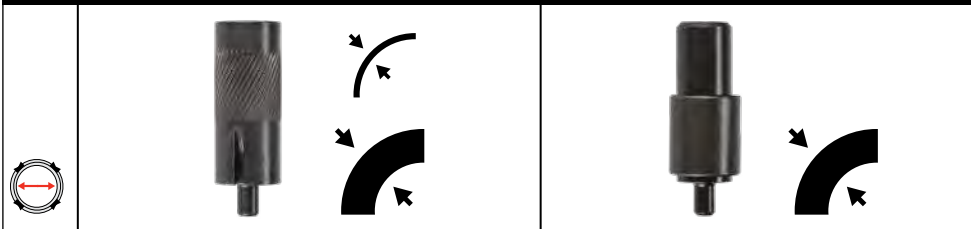
METRIC – INSTALLATION TOOLS

MM	PART #	PART #
4.00	-	HDM4
5.00	3600-190T	-
6.00	3600-250T	-
8.00	3600-312T	-
10.00	3600-375T	-
12.00	3600-500T	-
14.00	-	HDM14
16.00	3600-625T	-
18.00	-	HDM18
20.00	3600-875T	-
22.00	3600-875T	-
24.00	-	HDM24

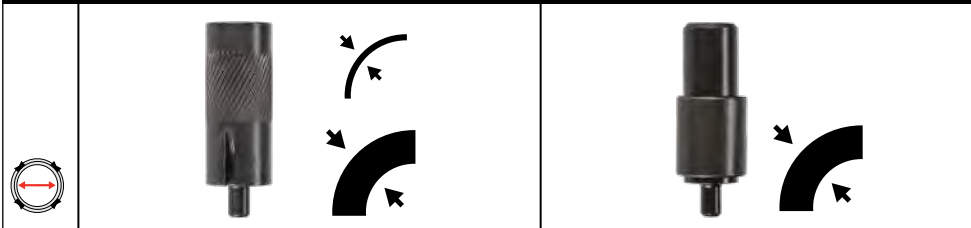
UNC / UNF – INSTALLATION TOOLS

INCH	PART #	PART #
8G	-	HD8
10G	3600-190T	-
1/4	3600-250T	-
5/16	3600-312T	-
3/8	3600-375T	-
7/16	3600-375T	-
1/2	3600-500T	-
9/16	3600-500T	-
5/8	3600-625T	-
3/4	3600-875T	-
7/8	3600-875T	-
1	3600-100T	-
1-1/8	-	HD1 1/8
1-1/4	-	HD1 1/4
1-1/2	-	HD1 1/2

Loksert

Loksert solid keylocking inserts are an easily installed thread assembly that is ideal for replacing damaged or worn threads in virtually any material – ferrous, non-ferrous and non-metallic.

They are constructed from high quality carbon steel or extremely hard wearing stainless steel. One piece Loksert inserts are supplied with the dove-tailed locking keys pre-assembled. The pre-positioned keys automatically position the insert at the correct depth below the surface of the parent material. Lokserts are suitable for repairing and creating threads in a wide range of applications including forgings and castings and are especially suited to situations that experience heavy wear and vibration - such as mining, construction and earthmoving equipment.

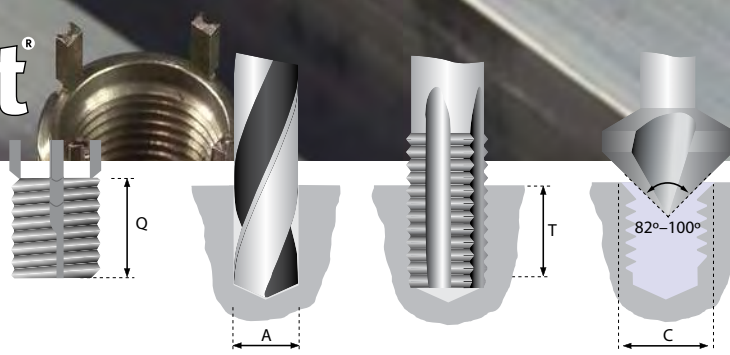

Technical
Metric

Internal Thread Class 6G	INSERT SPECIFICATIONS			Internal Thread Class 6G	DRILL, TAP & COUNTERSINK SPECIFICATIONS				Internal Thread Class 6G	REMOVAL SPECIFICATIONS	
	External Thread Class 6G	Q Nominal Length	Installation Tool		A Drill Size	Tap Size Class 6H	T Minimum Tapping Depth	C Min. Width Countersink		R1 Drill Size	R2 Minimum Drilling Depth
mm	mm	mm	Part #	mm	mm	mm	mm	mm	mm	mm	mm
THIN WALL				THIN WALL				THIN WALL			
M5 X 0.8	M8 X 1.25	8.0	3600-190T	M5 X 0.8	6.90	M8 X 1.25	9.50	8.25	M5 X 0.8	5.50	4.00
M6 X 1.0	M10 X 1.25	10.0	3600-250T	M6 X 1.0	8.80	M10 x 1.25	11.50	10.25	M6 X 1.0	7.50	4.75
M8 X 1.25	M12 x 1.25	12.0	3600-312T	M8 X 1.25	10.80	M12 x 1.25	13.50	12.25	M8 X 1.25	9.50	4.75
M8 X 1.0	M12 x 1.25	12.0	3600-312T	M8 X 1.0	10.80	M12 x 1.25	13.50	12.25	M8 X 1.0	9.50	4.75
M10 X 1.5	M14 x 1.5	14.0	3600-375T	M10 X 1.5	12.80	M14 x 1.5	15.50	14.25	M10 X 1.5	11.50	4.75
M10 X 1.25	M14 x 1.5	14.0	3600-375T	M10 X 1.25	12.80	M14 x 1.5	15.50	14.25	M10 X 1.25	11.50	4.75
M12 X 1.75	M16 x 1.5	16.0	3600-500T	M12 X 1.75	14.75	M16 x 1.5	17.50	16.25	M12 X 1.75	13.50	4.75
M12 X 1.25	M16 x 1.5	16.0	3600-500T	M12 X 1.25	14.75	M16 x 1.5	17.50	16.25	M12 X 1.25	13.50	4.75
HEAVY DUTY				HEAVY DUTY				HEAVY DUTY			
M4 X 0.7	M8 X 1.25	8.0	3600-4.00HT	M4 X 0.7	6.90	M8 X 1.25	9.50	8.25	M4 X 0.7	5.50	4.00
M5 X 0.8	M10 X 1.25	10.0	3600-190T	M5 X 0.8	8.80	M10 x 1.25	12.50	10.25	M5 X 0.8	7.50	4.75
M6 X 1.0	M12 x 1.25	12.0	3600-250T	M6 X 1.0	10.80	M12 x 1.25	14.50	12.25	M6 X 1.0	9.50	4.75
M8 X 1.25	M14 x 1.5	14.0	3600-312T	M8 X 1.25	12.80	M14 x 1.5	16.50	14.25	M8 X 1.25	11.50	4.75
M8 X 1.0	M14 x 1.5	14.0	3600-312T	M8 X 1.0	12.80	M14 x 1.5	16.50	14.25	M8 X 1.0	11.50	4.75
M10 X 1.5	M16 x 1.5	16.0	3600-375T	M10 X 1.5	14.75	M16 x 1.5	18.50	16.25	M10 X 1.5	13.50	4.75
M10 X 1.25	M16 x 1.5	16.0	3600-375T	M10 X 1.25	14.75	M16 x 1.5	18.50	16.25	M10 X 1.25	13.50	4.75
M12 X 1.75	M18 X 1.5	18.0	3600-500T	M12 X 1.75	16.75	M18 X 1.5	20.50	18.25	M12 X 1.75	15.50	4.75
M12 X 1.25	M18 X 1.5	18.0	3600-500T	M12 X 1.25	16.75	M18 X 1.5	20.50	18.25	M12 X 1.25	15.50	4.75
M14 X 2.0	M20 X 1.5	20.0	3600-14.00HT	M14 X 2.0	18.75	M20 X 1.5	22.50	20.25	M14 X 2.0	17.50	4.75
M14 X 1.5	M20 X 1.5	20.0	3600-14.00HT	M14 X 1.5	18.75	M20 X 1.5	22.50	20.25	M14 X 1.5	17.50	4.75
M16 X 2.0	M22 X 1.5	22.0	3600-625T	M16 X 2.0	20.50	M22 X 1.5	24.50	22.25	M16 X 2.0	17.75	6.35
M16 X 1.5	M22 X 1.5	22.0	3600-625T	M16 X 1.5	20.50	M22 X 1.5	24.50	22.25	M16 X 1.5	17.75	6.35
M18 X 1.5	M24 X 1.5	24.0	3600-18.00HT	M18 X 1.5	22.50	M24 X 1.5	26.50	24.25	M18 X 1.5	19.75	6.35
M20 X 2.5	M30 X 2.0	30.0	3600-875T	M20 X 2.5	28.00	M30 X 2.0	34.50	30.25	M20 X 2.5	25.75	6.35
M20 X 1.5	M30 X 2.0	30.0	3600-875T	M20 X 1.5	28.00	M30 X 2.0	34.50	30.25	M20 X 1.5	25.75	6.35
M22 X 1.5	M32 X 2.0	32.0	3600-22.00HT	M22 X 1.5	30.00	M32 X 2.0	36.50	32.25	M22 X 1.5	27.75	6.35
M24 X 3.0	M33 X 2.0	33.0	3600-24.00HT	M24 X 3.0	31.00	M33 X 2.0	37.50	33.25	M24 X 3.0	28.75	6.35
M24 X 2.0	M33 X 2.0	33.0	3600-24.00HT	M24 X 2.0	31.00	M33 X 2.0	37.50	33.25	M24 X 2.0	28.75	6.35

THIN WALL AND HEAVY DUTY LOKSERTS

Insert Material

Carbon Steel - C1215 or equivalent
Stainless Steel - 303 or equivalent

Keys

302 CRES or equivalent

Finish

Carbon Steel
Zinc Phosphate;
Stainless Steel - Passivated

Tolerances

±0.010 inch or
±0.25mm
unless specified otherwise



REMOVAL



1 DRILL
Drill out the material between the locking keys and the internal thread to the specified depth.

Note: Drill size and drilling depth are shown in the loksert technical tables.



2 DEFLECT
Deflect locking keys inward and break off



3 REMOVE
Remove the insert from the hole by winding it out using a screw extractor or similar type tool.



4 INSERT
A new loksert insert of exactly the same size can be installed in the original hole.

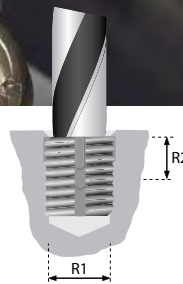

Internal Thread Class 2B	INSERT SPECIFICATIONS			Internal Thread Class 2B	DRILL, TAP & COUNTERSINK SPECIFICATIONS				Internal Thread Class 2B	REMOVAL SPECIFICATIONS	
	External Thread Mod Class 2A	Q Nominal Length	Installation Tool		A Drill Size	Tap Size Class 2B	T Minimum Tapping Depth	C Min. Width Countersink		R1 Drill Size	R2 Minimum Drilling Depth
inch	inch	inch	Part #	inch	inch	inch	inch	inch	inch	inch	inch
THIN WALL				THIN WALL				THIN WALL			
10G X 24	5/16 X 18	0.31	3600-190T	10G X 24	"I"	5/16 X 18	0.37	0.32	10G X 24	7/32	1/8
10G X 32	5/16 X 18	0.31	3600-190T	10G X 32	"I"	5/16 X 18	0.37	0.32	10G X 32	7/32	1/8
1/4 X 20	3/8 X 16	0.37	3600-250T	1/4 X 20	"Q"	3/8 X 16	0.43	0.38	1/4 X 20	9/32	3/16
1/4 X 28	3/8 X 16	0.37	3600-250T	1/4 X 28	"Q"	3/8 X 16	0.43	0.38	1/4 X 28	9/32	3/16
5/16 X 18	7/16 X 14	0.43	3600-312T	5/16 X 18	"X"	7/16 X 14	0.50	0.44	5/16 X 18	11/32	3/16
5/16 X 24	7/16 X 14	0.43	3600-312T	5/16 X 24	"X"	7/16 X 14	0.50	0.44	5/16 X 24	11/32	3/16
3/8 X 16	1/2 X 13	0.50	3600-375T	3/8 X 16	29/64	1/2 X 13	0.56	0.51	3/8 X 16	13/32	3/16
3/8 X 24	1/2 X 13	0.50	3600-375T	3/8 X 24	29/64	1/2 X 13	0.56	0.51	3/8 X 24	13/32	3/16
7/16 X 14	9/16 X 12	0.56	3600-375T	7/16 X 14	33/64	9/16 X 12	0.62	0.57	7/16 X 14	15/32	3/16
7/16 X 20	9/16 X 12	0.56	3600-375T	7/16 X 20	33/64	9/16 X 12	0.62	0.57	7/16 X 20	15/32	3/16
1/2 X 13	5/8 X 11	0.62	3600-500T	1/2 X 13	37/64	5/8 X 11	0.68	0.63	1/2 X 13	17/32	3/16
1/2 X 20	5/8 X 11	0.62	3600-500T	1/2 X 20	37/64	5/8 X 11	0.68	0.63	1/2 X 20	17/32	3/16
HEAVY DUTY				HEAVY DUTY				HEAVY DUTY			
8G X 32	5/16 X 18	0.31	3600-8GHT	8G X 32	"I"	5/16 X 18	0.37	0.32	8G X 32	7/32	1/8
10G X 24	3/8 X 16	0.31	3600-190T	10G X 24	"Q"	3/8 X 16	0.37	0.38	10G X 24	9/32	1/8
10G X 32	3/8 X 16	0.31	3600-190T	10G X 32	"Q"	3/8 X 16	0.37	0.38	10G X 32	9/32	1/8
1/4 X 20	7/16 X 14	0.37	3600-250T	1/4 X 20	"X"	7/16 X 14	0.43	0.44	1/4 X 20	11/32	3/16
1/4 X 28	7/16 X 14	0.37	3600-250T	1/4 X 28	"X"	7/16 X 14	0.43	0.44	1/4 X 28	11/32	3/16
5/16 X 18	1/2 X 13	0.43	3600-312T	5/16 X 18	29/64	1/2 X 13	0.50	0.51	5/16 X 18	13/32	3/16
5/16 X 24	1/2 X 13	0.43	3600-312T	5/16 X 24	29/64	1/2 X 13	0.50	0.51	5/16 X 24	13/32	3/16
3/8 X 16	9/16 X 12	0.50	3600-375T	3/8 X 16	33/64	9/16 X 12	0.56	0.57	3/8 X 16	15/32	3/16
3/8 X 24	9/16 X 12	0.50	3600-375T	3/8 X 24	33/64	9/16 X 12	0.56	0.57	3/8 X 24	15/32	3/16
7/16 X 14	5/8 X 11	0.62	3600-375T	7/16 X 14	37/64	5/8 X 11	0.68	0.63	7/16 X 14	17/32	3/16
7/16 X 20	5/8 X 11	0.62	3600-375T	7/16 X 20	37/64	5/8 X 11	0.68	0.63	7/16 X 20	17/32	3/16
1/2 X 13	3/4 X 16	0.62	3600-500T	1/2 X 13	45/64	3/4 X 16	0.68	0.76	1/2 X 13	21/32	3/16
1/2 X 20	3/4 X 16	0.62	3600-500T	1/2 X 20	45/64	3/4 X 16	0.68	0.76	1/2 X 20	21/32	3/16
9/16 X 12	3/4 X 16	0.81	3600-500T	9/16 X 12	45/64	3/4 X 16	0.94	0.76	9/16 X 12	21/32	3/16
9/16 X 18	3/4 X 16	0.81	3600-500T	9/16 X 18	45/64	3/4 X 16	0.94	0.76	9/16 X 18	21/32	3/16
5/8 X 11	7/8 X 14	0.87	3600-625T	5/8 X 11	53/64	7/8 X 14	1.00	0.88	5/8 X 11	25/32	5/16
5/8 X 18	7/8 X 14	0.87	3600-625T	5/8 X 18	53/64	7/8 X 14	1.00	0.88	5/8 X 18	25/32	5/16
3/4 X 10	1-1/8 X 12	1.12	3600-875T	3/4 X 10	1-1/16	1-1/8 X 12	1.31	1.14	3/4 X 10	31/32	5/16
3/4 X 16	1-1/8 X 12	1.12	3600-875T	3/4 X 16	1-1/16	1-1/8 X 12	1.31	1.14	3/4 X 16	31/32	5/16
7/8 X 9	1-1/4 X 12	1.25	3600-875T	7/8 X 9	1-3/16	1-1/4 X 12	1.44	1.27	7/8 X 9	1-3/32	5/16
7/8 X 14	1-1/4 X 12	1.25	3600-875T	7/8 X 14	1-3/16	1-1/4 X 12	1.44	1.27	7/8 X 14	1-3/32	5/16
1 X 8	1-3/8 X 12	1.37	3600-100T	1 X 8	1-5/16	1-3/8 X 12	1.56	1.39	1 X 8	1-7/32	5/16
1 X 12	1-3/8 X 12	1.37	3600-100T	1 X 12	1-5/16	1-3/8 X 12	1.56	1.39	1 X 12	1-7/32	5/16
1 X 14	1-3/8 X 12	1.37	3600-100T	1 X 14	1-5/16	1-3/8 X 12	1.56	1.39	1 X 14	1-7/32	5/16
1-1/8 X 7	1-1/2 X 12	1.62	3600-1.1/8HT	1-1/8 X 7	1-7/16	1-1/2 X 12	1.84	1.52	1-1/8 X 7	1-11/32	5/16
1-1/8 X 12	1-1/2 X 12	1.62	3600-1.1/8HT	1-1/8 X 12	1-7/16	1-1/2 X 12	1.84	1.52	1-1/8 X 12	1-11/32	5/16
1-1/4 X 7	1-5/8 X 12	1.81	3600-1.1/4HT	1-1/4 X 7	1-9/16	1-5/8 X 12	2.06	1.64	1-1/4 X 7	1-15/32	5/16
1-1/4 X 12	1-5/8 X 12	1.81	3600-1.1/4HT	1-1/4 X 12	1-9/16	1-5/8 X 12	2.06	1.64	1-1/4 X 12	1-15/32	5/16
1-1/2 X 6	1-7/8 X 12	2.00	3600-1.1/2HT	1-1/2 X 6	1-13/16	1-7/8 X 12	2.28	1.89	1-1/2 X 6	1-23/32	5/16
1-1/2 X 12	1-7/8 X 12	2.00	3600-1.1/2HT	1-1/2 X 12	1-13/16	1-7/8 X 12	2.28	1.89	1-1/2 X 12	1-23/32	5/16

THIN WALL AND HEAVY DUTY LOKSERTS

Keys

Inserts with internal thread of 5/16" (M7) or larger have 4 locking keys. Smaller sizes have 2 keys.

Tap Drill Hole

0.234 - 0.500 = +0.004 / -0.001

Tolerance Inch

over 0.500 = +0.005 / -0.001

Tap Drill Hole

6.90 - 10.80 = +0.100 / -0.025

Tolerance Metric

over 12.80 = +0.130 / -0.025



For Metal

Bulk

STRONG THREADS IN METAL... EASY STEPS

BONDSERT provide a stronger fastener assembly in soft materials such as aluminum, magnesium and even cast iron. They can be used for repairing stripped threads, and for use in creating stronger threads in original equipment.

BONDSERT external threads are manufactured with standard size and pitch to permit the use of standard drills and taps. BONDSERT can be installed with a screwdriver, bolt/jam nut, or power drive tool.

BONDSERT are vibration resistant. Within minutes of installation, the Loctite™ 204 adhesive begins to set, and the newly installed inserts are fastener-ready within 5 minutes and will not back out. In addition, the Loctite™ 204 adhesive seals against liquids and gases up to 6,000 psi when fully cured after 72 hours.

Drill hole with standard drill.



Tap hole with standard tap.



Power drive tools are available for high volume installation... See insert tables for catalog numbers and sizes.



CARBON STEEL INSERTS FOR METAL

COARSE THREAD SIZES

BONDSERT Part No.	Internal Thread	External Thread	Length in.	Tap Drill Size	Tap Size	Minimum Full Thread Depth	Drive Tool Catalog No.
3332-4GHW	4-40	10-32	.250	5/32	10-32	9/32	—
3332-6GHW	6-32	1/4-20	.280	7	1/4-20	11/32	3300-006
3332-8GHW	8-32	5/16-18	.290	F	5/16-18	7/16	3300-1
3332-10GHW	10-24	3/8-16	.406	5/16	3/8-16	15/32	3300-2
3332-1/4HW	1/4-20	7/16-14	.437	23/64	7/16-14	1/2	3300-3
329-401	1/4-20	7/16-14	1.000	23/64	7/16-14	1-1/8	500-3
3332-5/16HW	5/16-18	1/2-13	.484	27/64	1/2-13	9/16	3300-4
329-501	5/16-18	1/2-13	1.000	27/64	1/2-13	1-1/8	500-4
3332-3/8HW	3/8-16	9/16-12	.515	31/64	9/16-12	19/32	3300-5
329-601	3/8-16	9/16-12	1.000	31/64	9/16-12	1-1/8	500-5
3332-7/16HW	7/16-14	5/8-11	.656	17/32	5/8-11	23/32	3300-6
3332-1/2HW	1/2-13	3/4-10	.656	21/32	3/4-10	3/4	3300-7
3332-1/2HW	1/2-13	3/4-10	1.000	21/32	3/4-10	1-1/8	3300-7
3332-9/16HW	9/16-12	3/4-10	.656	21/32	3/4-10	3/4	3300-8
3332-5/8HW	5/8-11	7/8-9	.687	49/64	7/8-9	13/16	3300-9
3332-5/8X1.125HW	5/8-11	7/8-9	1.125	49/64	7/8-9	1-1/4	3300-9
3332-3/4HW	3/4-10	1-8	.781	7/8	1-8	7/8	--
3332-7/8HW	7/8-9	1-1/4-7	1.125	1-7/64	1-1/4-7	1-1/4	—
3332-1HW	1-8	1-3/8-12	1.250	1-9/32	1-3/8-12	1-3/8	—

FINE THREAD SIZES

BONDSERT Part No.	Internal Thread	External Thread	Length in.	Tap Drill Size	Tap Size	Minimum Full Thread Depth	Drive Tool Catalog No.
3334-10GHW	10-32	3/8-16	.406	5/16	3/8-16	15/32	3300-2
3334-1/4HW	1/4-28	7/16-14	.437	23/64	7/16-14	1/2	3300-3
3334-5/16HW	5/16-24	1/2-13	.484	27/64	1/2-13	9/16	3300-4
3334-3/8HW	3/8-24	9/16-12	.515	31/64	9/16-12	19/32	3300-5
3334-7/16HW	7/16-20	5/8-11	.656	17/32	5/8-11	23/32	3300-6
3334-1/2HW	1/2-20	3/4-10	.656	21/32	3/4-10	3/4	3300-7
3334-9/16HW	9/16-18	3/4-10	.656	21/32	3/4-10	3/4	3300-8
3334-5/8HW	5/8-18	7/8-9	.687	49/64	7/8-9	13/16	3300-9
3334-3/4HW	3/4-16	1-8	.781	7/8	1-8	7/8	--
3334-7/8HW	7/8-14	1-1/4-7	1.125	1-7/64	1-1/4-7	1-1/4	—
3334-1HW	1-14	1-3/8-12	1.250	1-9/32	1-3/8-12	1-3/8	—

EXTRA HEAVY WALL — COARSE THREAD SIZES

BONDSERT Part No.	Internal Thread	External Thread	Length in.	Tap Drill Size	Tap Size	Minimum Full Thread Depth	Drive Tool Catalog No.
3332-1/4XHW	1/4-20	1/2-13	.484	27/64	1/2-13	9/16	3300-3
3332-5/16HXHW	5/16-18	9/16-12	.515	31/64	9/16-12	19/32	3300-4
3332-3/8XHW	3/8-16	5/8-11	.656	17/32	5/8-11	23/32	3300-5
3332-1/2XHW	1/2-13	7/8-9	.687	49/64	7/8-9	13/16	—
3332-5/8XHW	5/8-11	1-8	.781	7/8	1-8	7/8	—

THIN WALL — COARSE THREAD SIZES

BONDSERT Part No.	Internal Thread	External Thread	Length in.	Tap Drill Size	Tap Size	Minimum Full Thread Depth	Drive Tool Catalog No.
3332-10GTW	10-24	5/16-18	.312	I	5/16-18	.375	3300-2
3332-1/4TW	1/4-20	3/8-16	.375	Q	3/8-16	.437	3300-3
3332-5/16TW	5/16-18	7/16-14	.437	X	7/16-14	.500	3300-5
3332-3/8TW	3/8-16	1/2-13	.500	29/64	1/2-13	.560	3300-5
3332-7/16TW	7/16-14	9/16-12	.560	33/64	9/16-12	.620	3300-6
3332-1/2TW	1/2-13	5/8-11	.620	37/64	5/8-11	.680	3300-7

THIN WALL — FINE THREAD SIZES

BONDSERT Part No.	Internal Thread	External Thread	Length in.	Tap Drill Size	Tap Size	Minimum Full Thread Depth	Drive Tool Catalog No.
3334-10GTW	10-32	5/16-18	.312	I	5/16-18	.375	3300-2
3334-1/4TW	1/4-28	3/8-16	.375	Q	3/8-16	.437	3300-3
3334-5/16TW	5/16-24	7/16-14	.437	X	7/16-14	.500	3300-4
3334-3/8TW	3/8-24	1/2-13	.500	29/64	1/2-13	.560	3300-5
3334-7/16TW	7/16-20	9/16-12	.560	33/64	9/16-12	.620	3300-6
3334-1/2TW	1/2-20	5/8-11	.620	37/64	5/8-11	.680	3300-7

THIN WALL — METRIC THREAD SIZES

BONDSERT Part No.	Internal Thread	External Thread	Length in.	Tap Drill Size	Tap Size	Minimum Full Thread Depth	Drive Tool Catalog No.
3320-4.00TWF	M4-0.7	5/16-18	.312	I	5/16-18	.375	3300-2
3320-5.00TWF	M5-0.8	5/16-18	.312	I	5/16-18	.375	3300-2
3320-6.00TWF	M6-1.0	3/8-16	.375	Q	3/8-16	.437	3300-3
3320-8.00TWF	M8-1.25	7/16-14	.437	X	7/16-14	.500	3300-4
3320-10.00TWF	M10-1.5	1/2-13	.500	29/64	1/2-13	.560	3300-5
3320-12.00TWF	M12-1.75	5/8-11	.620	37/64	5/8-11	.680	3300-7

THIN WALL INSTALLATION KITS

Kit Part No.	Internal Thread	Kit Part No.	Internal Thread
3332-10GTWK	10-24	3332-3/8TWK	3/8-16
3334-10G-TWK	10-32	3334-3/8TWK	3/8-24
3332-1/4TWK	1/4-20	3332-7/16TWK	7/16-14
3334-1/4TWK	1/4-28	3334-7/16TWK	7/16-20
3332-5/16TWK	5/16-18	3332-1/2TWK	1/2-13
3334-5/16TWK	5/16-24	3334-1/2TWK	1/2-20

Each kit includes 20 inserts plus a drill, tap, and installation tool.



Metal

Bulk



METRIC THREAD SIZES — METRIC INTERNAL/METRIC EXTERNAL

BONDSERT Part No.	Internal Thread	External Thread	Length	Tap Drill Size	Tap Size	Minimum Full Thread Depth	Drive Tool Catalog No.
3320-3.00HWM	M3-0.5	M6-1.0	6.5mm	5.1mm	M6-1.0	7.8mm	—
3320-4.00HWM	M4-0.7	M8-1.25	7.5mm	6.9mm	M8-1.25	9.0mm	3300-1
3320-5.00HWM	M5-0.8	M8-1.25	7.5mm	6.9mm	M8-1.25	9.0mm	3300-1
3320-6.00HWM	M6-1.0	M10-1.5	10.5mm	8.6mm	M10-1.5	12.0mm	3300-3
3320-8.00HWM	M8-1.25	M12-1.75	12.5mm	10.4mm	M12-1.75	14.5mm	3300-4
3320-10.00HWM	M10-1.5	M16-2.0	17.0mm	14.0mm	M16-2.0	19.0mm	3300-5
3320-12.00HWM	M12-1.75	M16-2.0	17.0mm	14.0mm	M16-2.0	19.0mm	3300-6
3320-16.00HWM	M16-2.0	M24-3.0	20.0mm	21.0mm	M24-3.0	24.0mm	3300-8
3320-20.00HWM	M20-2.5	M36-4.0	30.0mm	33.0mm	M36-4.0	35.0mm	—

METRIC THREAD SIZES — U.S. INTERNAL/METRIC EXTERNAL

BONDSERT Part No.	Internal Thread	External Thread	Length (in.)	Tap Drill Size	Tap Size	Minimum Full Thread Depth	Drive Tool Catalog No.
3332-GGHWM	6-32	M6-1.0	.256	5.1mm	M6-1.0	7.8mm	--
3332-8GHWM	8-32	M8-1.25	.295	6.9mm	M8-1.25	9.0mm	3300-1
3332-10GHWM	10-24	M8-1.25	.295	6.9mm	M8-1.25	12.0mm	3300-2
3334-10GHWM	10-32	M8-1.25	.295	6.9mm	M8-1.25	12.0mm	3300-2
3332-1/4HWM	1/4-20	M10-1.5	.413	8.6mm	M10-1.5	14.5mm	3300-3
3332-5/16HWM	5/16-18	M12-1.75	.492	10.4mm	M12-1.75	14.5mm	3300-4
3332-3/8HWM	3/8-16	M16-2.0	.669	14.0mm	M16-2.0	19.0mm	3300-5
3332-1/2HWM	1/2-13	M16-2.0	.669	14.0mm	M16-2.0	19.0mm	3300-7

METRIC THREAD SIZES — METRIC INTERNAL/U.S. EXTERNAL

BONDSERT Part No.	Internal Thread	External Thread	Length	Tap Drill Size	Tap Size	Minimum Full Thread Depth	Drive Tool Catalog No.
3320-6.00HWF	M6-1.0	3/8-16	.406	5/16	3/8-16	15/32	3300-3
3320-8.00HWF	M8-1.25	1/2-13	.484	27/64	1/2-13	9/16	3300-4
3320-10.00HWF	M10-1.50	9/16-12	.515	31/64	9/16-12	19/32	3300-5
3321-10.00HWF	M10-1.25	9/16-12	.515	31/64	9/16-12	19/32	3300-5
3320-12.00HWF	M12-1.75	3/4-10	.656	21/32	3/4-10	3/4	3300-6
3320-14.00HWF	M14-2.0	7/8-9	.687	49/64	7/8-9	13/16	3300-7
3320-16.00HWF	M16-2.0	1-8	.781	7/8	1-8	7-8	3300-8

CARBON STEEL INSERTS - AUTOMOTIVE



AUTOMOTIVE DESIGNS

BONDSERT Part No.	Internal Thread	External Thread	Length	Tap Drill Size	Tap Size
SPARK PLUG SIZES					
3322-10.00X1/2	M10 -1.0	9/16-18	.453	33/64	9/16-18
3322-12.00X1/2	M12-1.25	5/8-18	.453	37/64	5/8-18
3322-12.00X3/4	M12-1.25	5/8-18	.703	37/64	5/8-18
3322-14.00X1/2M	M14 -1.25	M18-1.5	11.5mm	16.5mm	M18-1.5
3322-14.00X3/8	M14 -1.25	3/4-16	.328	11/16	3/4-16
3322-14.00X1/2	M14 -1.25	3/4-16	.453	11/16	3/4-16
3322-14.00X3/4	M14 -1.25	3/4-16	.703	11/16	3/4-16
3322-18.00X1/2	M18-1.5	1-12	.453	59/64	1-12

COARSE THREAD SIZES IN 303 STAINLESS STEEL

BONDSERT Part No.	Internal Thread	External Thread	Length in.	Tap Drill Size	Tap Size	Minimum Full Thread Depth	Drive Tool Catalog No.
3332-4GHWSS	4-40	10-32	.250	5/32	10-32	9/32	—
3332-6GHWSS	6-32	1/4-20	.280	7	1/4-20	11/32	—
3332-8GHWSS	8-32	5/16-18	.290	F	5/16-18	7/16	3300-1
3332-10GHWSS	10-24	3/8-16	.406	5/16	3/8-16	15/32	3300-2
3332-1/4HWSS	1/4-20	7/16-14	.437	23/64	7/16-14	1/2	3300-3
3332-5/16HWSS	5/16-18	1/2-13	.484	27/64	1/2-13	9/16	3300-4
3332-3/8HWSS	3/8-16	9/16-12	.515	31/64	9/16-12	19/32	3300-5
3332-7/16HWSS	7/16-14	5/8-11	.656	17/32	5/8-11	23/32	3300-6
3332-1/2HWSS	1/2-13	3/4-10	.656	21/32	3/4-10	3/4	3300-7
3332-5/8HWSS	5/8-11	7/8-9	.687	49/64	7/8-9	13/16	3300-8
3332-3/4HWSS	3/4-10	1-8	.781	7/8	1-8	7/8	3300-9

FINE THREAD SIZES IN 303 STAINLESS STEEL

BONDSERT Part No.	Internal Thread	External Thread	Length in.	Tap Drill Size	Tap Size	Minimum Full Thread Depth	Drive Tool Catalog No.
3334-10GHWSS	10-32	3/8-16	.406	5/16	3/8-16	15/32	3300-2
3334-1/4HWSS	1/4-28	7/16-14	.437	23/64	7/16-14	1/2	3300-3
3334-5/16HWSS	5/16-24	1/2-13	.484	27/64	1/2-13	9/16	3300-4
3334-3/8HWSS	3/8-24	9/16-12	.515	31/64	9/16-12	19/32	3300-5
3334-7/16HWSS	7/16-20	5/8-11	.656	17/32	5/8-11	23/32	3300-6
3334-1/2HWSS	1/2-20	3/4-10	.656	21/32	3/4-10	3/4	3300-7

METRIC THREAD SIZES IN 303 STAINLESS STEEL — METRIC INTERNAL/METRIC EXTERNAL

BONDSERT Part No.	Internal Thread	External Thread	Length	Tap Drill Size	Tap Size	Minimum Full Thread Depth	Drive Tool Catalog No.
3320-3.00HWSS	M3-0.5	M6-1.0	6.5mm	5.1mm	M6-1.0	7.8mm	—
3320-4.00HWSS	M4-0.7	M8-1.25	7.5mm	6.9mm	M8-1.25	9.0mm	3300-1
3320-5.00HWSS	M5-0.8	M8-1.25	7.5mm	6.9mm	M8-1.25	9.0mm	3300-1
3320-6.00HWSS	M6-1.0	M10-1.5	10.5mm	8.6mm	M10-1.5	12.0mm	3300-3
3320-8.00HWSS	M8-1.25	M12-1.75	12.5mm	10.4mm	M12-1.75	14.5mm	3300-4
3320-10.00HWSS	M10-1.5	M16-2.0	17.0mm	14.0mm	M16-2.0	19.0mm	3300-5
3320-12.00HWSS	M12-1.75	M16-2.0	17.0mm	14.0mm	M16-2.0	19.0mm	3300-6
3320-16.00HWSS	M16-2.0	M24-3.0	20.0mm	21.0mm	M24-3.0	24.0mm	3300-8

METRIC THREAD SIZES IN 303 STAINLESS STEEL — METRIC INTERNAL/U.S. EXTERNAL

BONDSERT Part No.	Internal Thread	External Thread	Length	Tap Drill Size	Tap Size	Minimum Full Thread Depth	Drive Tool Catalog No.
3320-6.00HWSSF	M6-1.0	3/8-16	.406	5/16	3/8-16	15/32	3300-3
3320-8.00HWSSF	M8-1.25	1/2-13	.484	27/64	1/2-13	9/16	3300-4
3320-10.00HWSSF	M10-1.50	9/16-12	.515	31/64	9/16-12	19/32	3300-5
3321-10.00HWSSF	M10-1.25	9/16-12	.515	31/64	9/16-12	19/32	3300-5
3320-12.00HWSSF	M12-1.75	3/4-10	.656	21/32	3/4-10	3/4	3300-6
3320-14.00HWSSF	M14-2.0	7/8-9	.687	49/64	7/8-9	13/16	3300-7
3320-16.00HWSSF	M16-2.0	1-8	.781	7/8	1-8	7/8	3300-8

COARSE/FINE THREAD SIZES IN 316 STAINLESS STEEL

BONDSERT Part No.	Internal Thread	External Thread	Length in.	Tap Drill Size	Tap Size	Minimum Full Thread Depth	Drive Tool Catalog No.
3332-6GHWY	8-32	5/16-18	.290	F	5/16-18	7/16	3300-1
3332-10GHWY	10-24	3/8-16	.406	5/16	3/8-16	15/32	3300-2
3334-10GHWY	10-32	3/8-16	.406	5/16	3/8-16	15/32	3300-2
3332-1/4HWY	1/4-20	7/16-14	.437	23/64	7/16-14	1.125	3300-3
3332-5/16HWY	5/16-18	1/2-13	.484	27/64	1/2-13	1.125	3300-4
3332-3/8HWY	3/8-16	9/16-12	.515	31/64	9/16-12	1.125	3300-5



For Metal

Kits



CARBON STEEL THREAD INSERTS FOR METAL - PREPACKAGED KITS

Kit Type	Kit Number	Quantity of Inserts	Insert Part Number	Internal Thread	External Thread
Coarse Thread #10 to 7/16"	3332-WK0	10	3332-10GHW	10-24	3/8-16
		10	3332-1/4HW	1/4-20	7/16-14
		10	3332-5/16HW	5/16-18	1/2-13
		10	3332-3/8HW	3/8-16	9/16-12
		8	3332-7/16HW	7/16-14	5/8-11
Coarse Thread #10 to 1/2"	3332-WK1	10	3332-10GHW	10-24	3/8-16
		10	3332-1/4HW	1/4-20	7/16-14
		10	3332-5/16HW	5/16-18	1/2-13
		10	3332-3/8HW	3/8-16	9/16-12
		6	3332-1/2HW	1/2-13	3/4-10
Coarse Thread 1/2" to 1"	3332-WK2	6	3332-1/2HW	1/2-13	3/4-10
		7	3332-5/8HW	5/8-11	7/8-9
		7	3332-3/4HW	3/4-10	1-8
		2	3332-1HW	1-8	1-3/8-12
Fine Thread #10 to 7/16"	3334-WK0	10	3334-10GHW	10-32	3/8-16
		10	3334-1/4HW	1/4-28	7/16-14
		10	3334-5/16HW	5/16-24	1/2-13
		10	3334-3/8HW	3/8-24	9/16-12
		8	3334-7/16HW	7/16-20	5/8-11
Fine Thread #10 to 1/2"	3334-WK1	10	3334-10GHW	10-32	3/8-16
		10	3334-1/4HW	1/4-28	7/16-14
		10	3334-5/16HW	5/16-24	1/2-13
		10	3334-3/8HW	3/8-24	9/16-12
		6	3334-1/2HW	1/2-20	3/4-10
Fine Thread 1/2" to 1"	3334-WK2	6	3334-1/2HW	1/2-20	3/4-10
		7	3334-5/8HW	5/8-18	7/8-9
		7	3334-3/4HW	3/4-16	1-8
		2	3334-1HW	1-14	1-3/8-12



Prepackaged kits containing a range of sizes are available.

Note: Because BONDsert inserts install with standard tools, our kits contain only inserts. Drills and taps are not included.



CARBON STEEL THREAD INSERTS FOR METAL — METRIC					
Kit Type		Quantity of Inserts	Insert Part Number	Internal Thread	External Thread
Metric Thread M3 to M8	3320-WK0	10	3320-3.00HW	M3-0.5	M6-1.0
		10	3320-4.00HW	M4-0.7	M8-1.25
		10	3320-5.00HW	M5-0.8	M8-1.25
		10	3320-6.00HW	M6-1.0	M10-1.5
		10	3320-6.00HW	M8-1.25	M12-1.75
Metric Thread M8 to M16	3320-WK1	10	3320-8.00HW	M8-1.25	M12-1.75
		10	3320-10.00HW	M10-1.5	M16-2.0
		8	3320-12.00HW	M12-1.75	M16-2.0
		5	3320-16.00HW	M16-2.0	M24-3.0
Coarse Thread #10 to 1/2"	3332-MWK1	10	3332-10GHWM	10-24	M10-1.5
		10	3332-1/4HWM	1/4-20	M12-1.75
		10	3332-5/16HWM	5/16-18	M12-1.75
		10	3332-3/8HWM	3/8-16	M16-2.0
		6	3332-1/2HWM	1/2-13	M16-2.0
Metric Thread M6 to M12	3320-FWK0	10	3320-6.00HWF	M6-1.0	3/8-16
		10	3320-8.00HWF	M8-1.25	1/2-13
		10	3320-10.00HWF	M10-1.5	9/16-12
		6	3320-12.00HWF	M12-1.75	3/4-10



STAINLESS STEEL THREAD INSERTS FOR METAL					
Kit Type		Quantity of Inserts	Insert Part Number	Internal Thread	External Thread
Coarse Thread 303 Stainless #10 to 1/2"	3332-SSWK1	10	3332-10GHWSS	10-24	3/8-16
		10	3332-1/4HWSS	1/4-20	7/16-14
		10	3332-5/16HWSS	5/16-18	1/2-13
		10	3332-3/8HWSS	3/8-16	9/16-12
		6	3332-1/2HWSS	1/2-13	3/4-10
Fine Thread 303 Stainless #10 to 1/2"	3334-SSWK1	10	3334-10GHWSS	10-32	3/8-16
		10	3334-1/4HWSS	1/4-28	7/16-14
		10	3334-5/16HWSS	5/16-24	1/2-13
		10	3334-3/8HWSS	3/8-24	9/16-12
		6	3334-1/2HWSS	1/2-20	3/4-10
Metric Thread 303 Stainless M3 to M8	3320-SSWK0	10	3320-3.00HWSS	M3-0.5	M6-1.0
		10	3320-4.00HWSS	M4-0.7	M8-1.25
		10	3320-5.00HWSS	M5-0.8	M8-1.25
		10	3320-6.00HWSS	M6-1.0	M10-1.5
		10	3320-8.00HWSS	M8-1.25	M12-1.75
Metric Thread 303 Stainless M8 to M16	3320-SSWK1	10	3320-8.00HWSS	M8-1.25	M12-1.75
		10	3320-10.00HWSS	M10-1.5	M16-2.0
		8	3320-12.00HWSS	M12-1.75	M16-2.0
		5	3320-16.00HWSS	M16-2.0	M24-3.0
Metric Thread 303 Stainless M6 to M12	3320-SSWK2	10	3320-6.00HWSSF	M6-1.0	3/8-16
		10	3320-8.00HWSSF	M8-1.25	1/2-13
		10	3320-10.00HWSSF	M10-1.5	9/16-12
		6	3320-12.00HWSSF	M12-1.75	3/4-10



Technical **HEAVY WALL - CARBON STEEL THREAD INSERTS FOR METAL**



PART NUMBER	INTERNAL THREAD 2B	EXTERNAL THREAD 2A	L	A	B	C	D
			(in.)	(in.)	(in.)	(in.)	(in.)
3332-4GHW	4-40	10-32	.250	.122	.064	.602	.065
3332-6GHW	6-32	1/4-20	.280	.148	.064	.062	.070
3332-8GHW	8-32	5/16-18	.290	.177	.064	.062	.075
3332-10GHW	10-24	3/8-16	.406	.201	.064	.070	.080
3334-10GHW	10-32	3/8-16	.406	.201	.064	.070	.080
3332-1/4HW	1/4-20	7/16-14	.437	.261	.072	.075	.085
3334-1/4HW	1/4-28	7/16-14	.437	.261	.072	.075	.085
3332-5/16HW	5/16-18	1/2-13	.484	.323	.081	.080	.090
3334-5/16HW	5/16-24	1/2-13	.484	.323	.081	.080	.095
3332-3/8HW	3/8-16	9/16-12	.515	.386	.091	.085	.095
3334-3/8HW	3/8-24	9/16-12	.515	.386	.091	.085	.115
3332-7/16HW	7/16-14	5/8-11	.656	.447	.130	.110	.115
3334-7/16HW	7/16-20	5/8-11	.656	.447	.130	.110	.115
3332-1/2HW	1/2-13	3/4-10	.656	.510	.130	.110	.115
3332-1/2X1HW	1/2-13	3/4-10	1.000	.510	.130	.110	.115
3334-1/2HW	1/2-20	3/4-10	.656	.510	.130	.110	.115
3332-9/16HW	9/16-12	3/4-10	.656	.578	.130	.110	.115
3334-9/16HW	9/16-18	3/4-10	.656	.578	.130	.110	.130
3332-5/8HW	5/8-11	7/8-9	.687	.640	.130	.125	.130
3332-5/8X1/125HW	5/8-11	7/8-9	1.125	.640	.130	.125	.130
3334-5/8HW	5/8-18	7/8-9	.687	.640	.130	.125	.130
3332-3/4HW	3/4-10	1-8	.781	.765	.130	.125	.130
3334-3/4HW	3/4-16	1-8	.781	.765	.130	.125	.130
3332-7/8HW	7/8-9	1-1/4-7	1.125	.890	.130	.135	.130
3334-7/8HW	7/8-14	1-1/4-7	1.125	.890	.130	.135	.130
3332-1HW	1-8	1-3/8-12	1.250	1.020	.130	.135	.140
3334-1HW	1-14	1-3/8-12	1.250	1.02	.130	.135	.140

335 SERIES - EXTRA HEAVY WALL - CARBON STEEL THREAD INSERTS FOR METAL

PART NUMBER	INTERNAL THREAD 2B	EXTERNAL THREAD 2A	L	A	B	C	D
			(in.)	(in.)	(in.)	(in.)	(in.)
3332-1/4XHW	1/4-20	1/2-13	.484	.261	.072	.075	.085
3332-5/16HXHW	5/16-18	9/16-12	.515	.323	.081	.080	.090
3332-3/8XHW	3/8-16	5/8-11	.515	.385	.130	.110	.115
3332-1/2XHW	1/2-13	7/8-9	.687	.640	.130	.125	.130
3332-5/8XHW	5/8-11	1-8	.781	.760	.130	.125	.130

550 SERIES STANDARD WALL - CARBON STEEL THREAD INSERTS FOR METAL - UNC/METRIC

PART NUMBER	INTERNAL THREAD 2B	EXTERNAL THREAD 2A	L	A	B	C	D
			(mm)	(in.)	(in.)	(in.)	(in.)
3332-GGHW	6-32	M6-1.0	6.5	0.148	0.064	0.062	0.070
3332-8GHW	8-32	M8-1.25	7.5	0.177	0.064	0.062	0.075
3332-10GHW	10-24	M8-1.25	7.5	0.201	0.064	0.070	0.80
3334-10GHW	10-32	M8-1.25	7.5	0.201	0.064	0.070	0.80
3332-1/4HWM	1/4-20	M10-1.5	10.5	0.261	0.072	0.075	0.085
3332-5/16HWM	5/16-18	M12-1.75	12.5	0.323	0.081	0.080	0.090
3332-3/8HWM	3/8-16	M16-2.0	17.0	0.386	0.091	0.085	0.085
3332-1/2HWM	1/2-13	M16-2.0	17.0	0.510	0.130	0.110	0.115

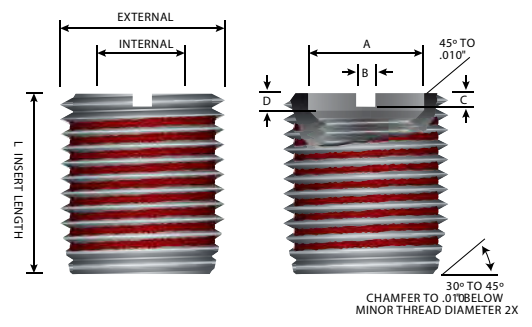

bondsert Thread Inserts
Material™ C12L14
Tolerance +/- .010"



Technical

650 SERIES HEAVY WALL - CARBON STEEL THREAD INSERTS FOR METAL - METRIC/UNC

PART NUMBER	INTERNAL THREAD 2B	EXTERNAL THREAD 2A	L (in.)	A (in.)	B (in.)	C (in.)	D (in.)
3332-1/2HWM	M6-1.0	3/8-16	.406	.246	.064	.070	.085
3320-8.00HWF	M8-1.25	1/2-13	.484	.323	.081	.080	.090
3320-10.00HWF	M10-1.5	9/16-12	.515	.403	.091	.085	.095
3321-10.00HWF	M10-1.25	9/16-12	.515	.403	.091	.085	.095
3320-12.00HWF	M12-1.75	3/4-10	.656	.482	.130	.110	.115
3320-14.00HWF	M14-2.0	7/8-9	.687	.640	.130	.125	.130
3320-16.00HWF	M16-2.0	1-8	.781	.781	.130	.125	.130

653 SERIES HEAVY WALL - STAINLESS STEEL THREAD INSERTS FOR METAL - METRIC/UNC

PART NUMBER	INTERNAL THREAD 2B	EXTERNAL THREAD 2A	L (in.)	A (in.)	B (in.)	C (in.)	D (in.)
3320-6.00HWSSF	M6-1.0	3/8-16	.406	.246	.064	.070	.085
3320-8.00HWSSF	M8-1.25	1/2-13	.484	.323	.081	.080	.090
3320-10.00HWSSF	M10-1.5	9/16-12	.515	.403	.091	.085	.095
3321-10.00HWSSF	M10-1.25	9/16-12	.515	.403	.091	.085	.095
3320-12.00HWSSF	M12-1.75	3/4-10	.656	.482	.130	.110	.115
3320-14.00HWSSF	M14-2.0	7/8-9	.687	.640	.130	.125	.130
653-16	M16-2.0	1-8	.781	.640	.130	.125	.130

HEAVY WALL - CARBON STEEL THREAD INSERTS FOR METAL METRIC

PART NUMBER	INTERNAL THREAD 2B	EXTERNAL THREAD 2A	L (in.)	A (in.)	B (in.)	C (in.)	D (in.)
3320-3.00HWM	M3-0.5	M6-1.0	.256	.128	.045	.062	.075
3320-4.00HWM	M4-0.7	M8-1.25	.295	.170	.065	.065	.075
3320-5.00HWM	M5-0.8	M8-1.25	.295	.210	.065	.065	.075
3320-6.00HWM	M6-1.0	M10-1.5	.413	.250	.072	.072	.080
3320-8.00HWM	M8-1.25	M12-1.75	.492	.328	.072	.072	.080
3320-10.00HWM	M10-2.5	M16-2.0	.669	.406	.103	.085	.095
3320-12.00HWM	M12-1.75	M16-2.0	.669	.485	.132	.110	.115
3320-16.00HWM	M16-2.0	M24-3.0	.787	.656	.132	.125	.130
330-20.00HWM	M20-2.5	M36-4.0	1.18	.807	.132	.132	.140

HEAVY WALL - STAINLESS STEEL THREAD INSERTS FOR METAL - METRIC

PART NUMBER	INTERNAL THREAD 2B	EXTERNAL THREAD 2A	L (in.)	A (in.)	B (in.)	C (in.)	D (in.)
3320-3.00HWSS	M3-0.5	M6-1.0	.256	.128	.045	.062	.075
3320-4.00HWSS	M4-0.7	M8-1.25	.295	.170	.065	.065	.075
3320-5.00HWSS	M5-0.8	M8-1.25	.295	.210	.065	.065	.075
3320-6.00HWSS	M6-1.0	M10-1.5	.413	.250	.072	.072	.080
3320-8.00HWSS	M8-1.25	M12-1.75	.492	.328	.072	.072	.080
3320-10.00HWSS	M10-2.5	M16-2.0	.669	.406	.103	.085	.095
3320-12.00HWSS	M12-1.75	M16-2.0	.669	.485	.132	.110	.115
3320-16.00HWSS	M16-2.0	M24-3.0	.787	.656	.132	.125	.130

AUTOMOTIVE INSERTS

PART NUMBER	INTERNAL THREAD	EXTERNAL THREAD	REACH (in.)	L (in.)
SPARK PLUG SIZES				
3322-10.00X1/2	M10-1.0	9/16-18	1/2	0.453
3322-12.00X1/2	M12-1.25	5/18-18	1/2	0.453
3322-12.00X3/4	M12-1.25	5/8-18	3/4	0.703
3322-14.00X1/2M	M14-1.25	M18-1.5	1/2	0.453
3322-14.00X3/8	M14-1.25	3/4-16	3/8	0.328
3322-14.00X1/2	M14-1.25	3/4-16	1/2	0.453
3322-14.00X3/4	M14-1.25	3/4-16	3/4	0.703
3322-18.00X1/2	M18-1.5	1-12	1/4	0.435

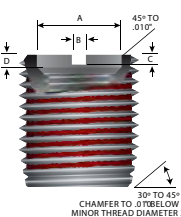
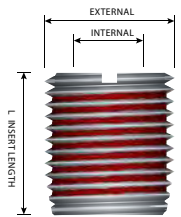
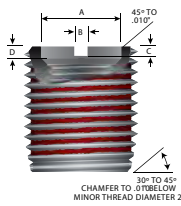
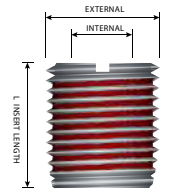



THIN WALL - CARBON STEEL THREAD INSERTS FOR METAL

PART NUMBER	INTERNAL	EXTERNAL	EXTERNAL THREAD		LENGTH
	THREAD SIZE	THREAD SIZE	MODIFIED MINOR DIA.	MAJOR DIA.	LENGTH
	(2B)	(2A)	A	B	J
UNIFIED COARSE					
3332-10GTW	10-24	5/16-18	.251-.254	.307-.311	.312
3332-1/4TW	1/4-20	3/8-16	.314-.318	.369-.373	.375
3332-5/16TW	5/16-18	7/16-14	.377-.381	.432-.436	.437
3332-3/8TW	3/8-16	1/2-13	.434-.438	.494-.498	.500
3332-7/16TW	7/16-14	9/16-12	.497-.557	.556-.560	.562
3332-1/2TW	1/2-13	5/8-11	.553-.557	.619-.623	.625
UNIFIED FINE					
3334-10GTW	10-32	5/16-18	.251-.254	.307-.311	.312
3334-1/4TW	1/4-28	3/8-16	.314-.318	.369-.373	.375
3334-5/16TW	5/16-24	7/16-14	.377-.381	.432-.436	.437
3334-3/8TW	3/8-24	1/2-13	.434-.501	.494-.498	.500
3334-7/16TW	7/16-20	9/16-12	.497-.501	.556-.560	.562
3334-1/2TW	1/2-20	5/8-11	.553-.557	.619-.623	.625
METRIC					
3320-4.00TWF	M4-0.7	5/16-18	.251-.254	.307-.311	.312
3320-5.00TWF	M5-0.8	5/16-18	.251-.254	.307-.311	.312
3320-6.00TWF	M6-1.0	3/8-16	.314-.318	.369-.373	.375
3320-8.00TWF	M8-1.25	7/16-14	.377-.381	.432-.436	.437
3320-10.00TWF	M10-1.5	1/2-13	.434-.438	.494-.498	.500
3320-12.00TWF	M12-1.75	5/8-11	.553	.619-.623	.625

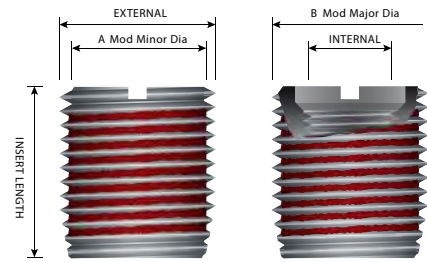

NOTE: The Thin Wall design requires a modified external thread. While the external thread pitch is standard, the minor diameter is larger than normal. So standard drill/tap combination does not apply. Preparing the hole for installation requires an oversize drill. For example, if a Thin Wall with a 5/8-11 external thread is being installed, a standard 37/64 drill is used as opposed to the typical 17/32, and tapped with a standard 5/8-11 tap.

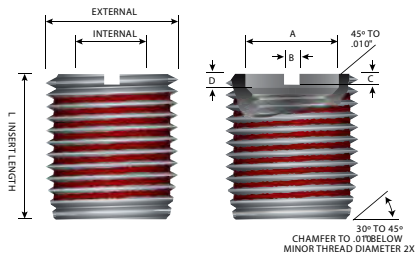

Thread Inserts
Material* C12L14
Tolerance +/- .010"

HEAVY WALL - STAINLESS STEEL THREAD INSERTS FOR METAL

PART NUMBER	INTERNAL THREAD 2B	EXTERNAL THREAD 2A	L	A	B	C	D
			(in.)	(in.)	(in.)	(in.)	(in.)
3332-4GHWSS	4-40	10-32	.250	.122	.064	.602	.065
3332-6GHWSS	6-32	1/4-20	.280	.148	.064	.062	.070
3332-8GHWSS	8-32	5/16-18	.290	.177	.064	.062	.075
3332-10GHWSS	10-24	3/8-16	.406	.201	.064	.070	.080
3334-10GHWSS	10-32	3/8-16	.406	.201	.064	.070	.080
3332-1/4HWSS	1/4-20	7/16-14	.437	.261	.072	.075	.085
3334-1/4HWSS	1/4-28	7/16-14	.437	.261	.072	.075	.085
3332-5/16HWSS	5/16-18	1/2-13	.484	.323	.081	.080	.090
3334-5/16HWSS	5/16-24	1/2-13	.484	.323	.081	.080	.090
3332-3/8HWSS	3/8-16	9/16-12	.515	.386	.091	.085	.095
3334-3/8HWSS	3/8-24	9/16-13	.515	.386	.091	.085	.095
3332-7/16HWSS	7/16-14	5/8-11	.656	.447	.130	.110	.115
3334-7/16HWSS	7/16-20	5/8-11	.656	.447	.130	.110	.115
3332-1/2HWSS	1/2-13	3/4-10	.656	.510	.130	.110	.115
3334-1/2HWSS	1/2-20	3/4-10	.656	.510	.130	.110	.115
3332-5/8HWSS	5/8-11	7/8-9	.687	.640	.130	.125	.130
3332-3/4HWSS	3/4-10	1-8	.781	.765	.130	.125	.130

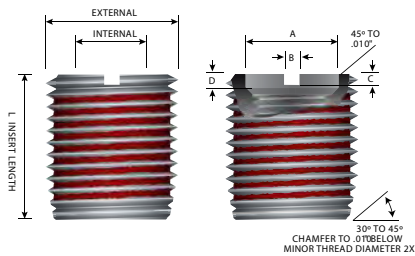
 Thread Inserts
 Material™ 303
 Tolerance +/- .010"

STANDARD WALL THREAD INSERTS FOR METAL - 316 STAINLESS STEEL

PART NUMBER	INTERNAL THREAD 2B	EXTERNAL THREAD 2A	L	A	B	C	D
			(in.)	(in.)	(in.)	(in.)	(in.)
3332-6GHWY	8-32	5/16-18	0.290	0.177	0.064	0.062	0.075
3332-10GHWY	10-24	3/8-16	0.406	0.201	0.064	0.070	0.080
3334-10GHWY	10-32	3/8-16	0.406	0.201	0.064	0.070	0.080
3332-1/4HWY	1/4-20	7/16-14	0.437	0.261	0.072	0.075	0.085
3332-5/16HWY	5/16-18	1/2-13	0.484	0.323	0.081	0.080	0.090
3332-3/8HWY	3/8-16	9/16-12	0.515	0.386	0.091	0.085	0.095

 Thread Inserts
 Material™ 316
 Tolerance +/- .010"

powercoil[®]

loksert[®]

bondsert 

15340 Herriman Blvd.
Noblesville, IN 46060
317-723-5050 tel
317.723.5052 fax
sales@crossroad.bz
CrossroadDistributorSource.com

